

ALEKO®

Indoor Sauna Installation Manual

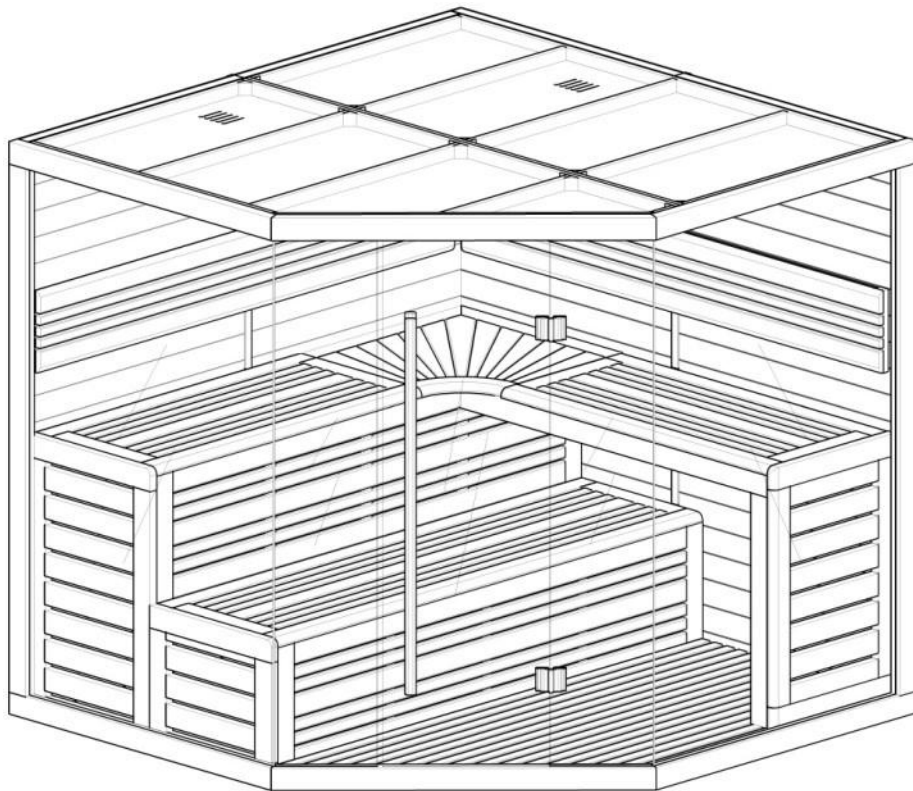

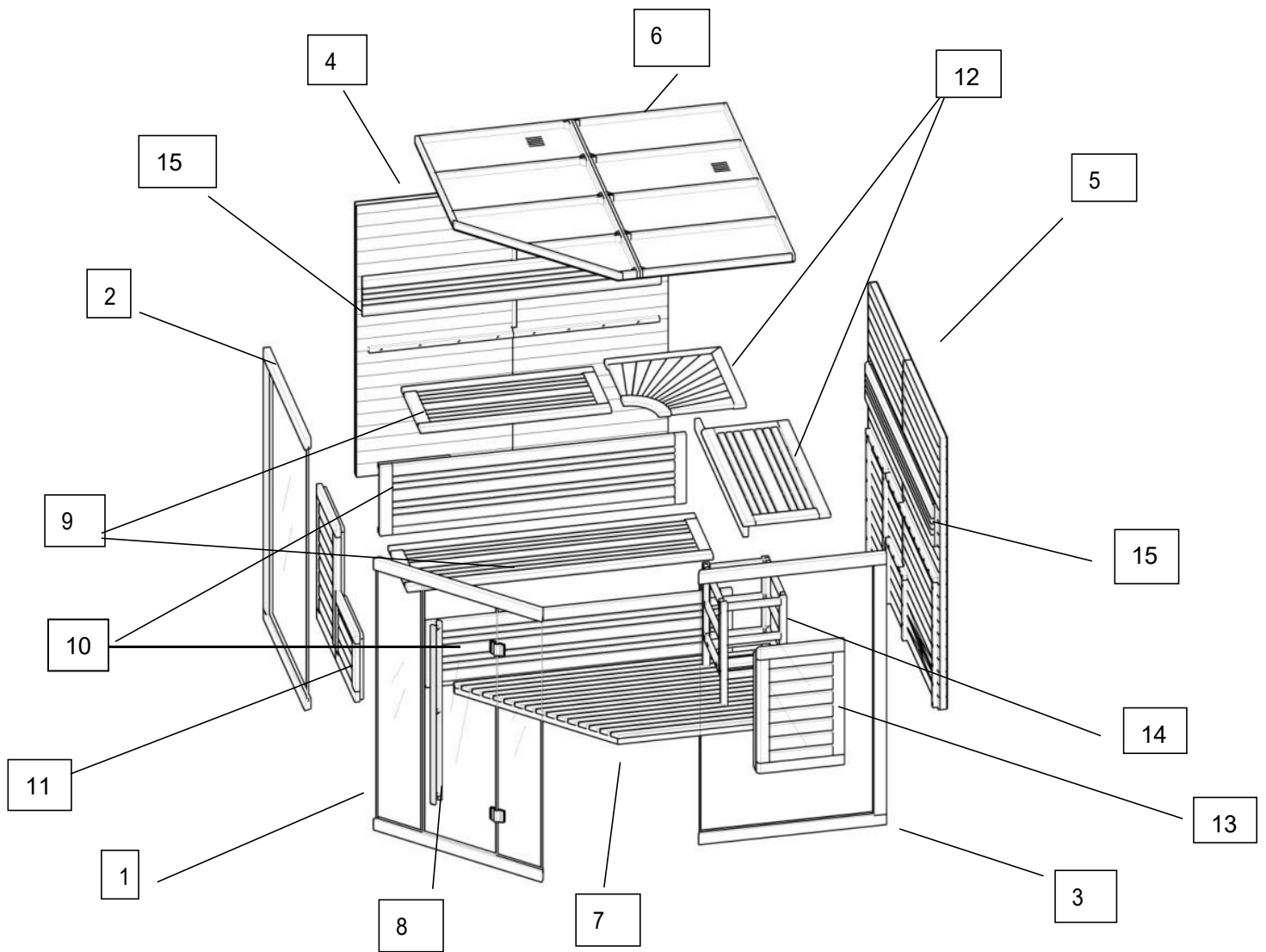

- 1. Front panel(left)--1pc
- 2. Left Side Panel--1pc
- 3. Right Side Panel--1pc
- 4. Back Panel A--1pcs
- 5. Back Panel B--1pcs
- 6. Roof panel--1 pc
- 7. Floor panel--1 pc
- 8. Door handle--1 set
- 9. Left side Bench--2 pcs
- 10. Left Bench Calf panel--2pcs
- 11. Left Bench support--1 pc
- 12. Right side Bench--2 pcs
- 13. Right side Bench support--1 pc
- 14. Heater fence--1 pc
- 15. Backrest-- 2pc

Assembly Instructions

Assembly of the sauna requires at least 3 adults to complete. Please read the instructions thoroughly before and during assembly to ensure proper installation of the sauna.

<1> LOCATION OF SAUNA

When you find a good location for your sauna, please notice the following.

1. The main power cord on the sauna must be easily accessible.
2. The location must be dry and leveled.
3. Please take out the backrest if it is behind the bottom panel.

<2> PLACING THE BACK PANEL

**Connect the small back panels with inside buckles. Please make sure that the inside buckles are properly secured in place. Use the metal part to fix them tightly by screws 3*25mm.

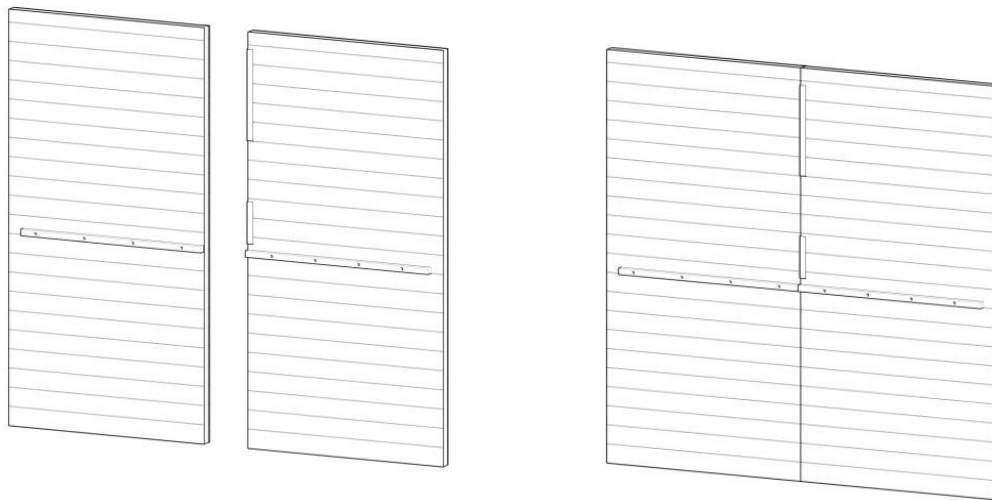

**Connect these two completed back panels by lining up buckles and fastening them securely in place.

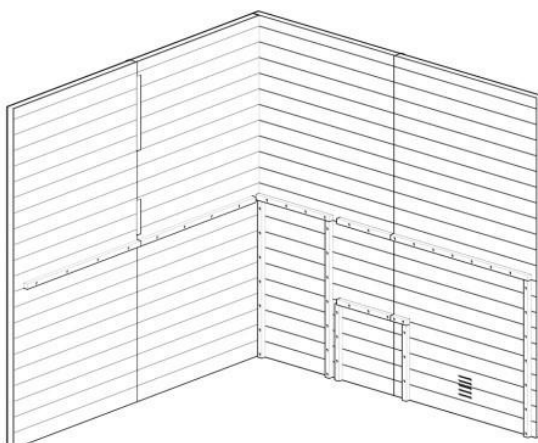

<3> CONNECTING BACK PANEL TO SIDE PANELS

A) Connect two vertical beams to the two back panels by outside buckles.

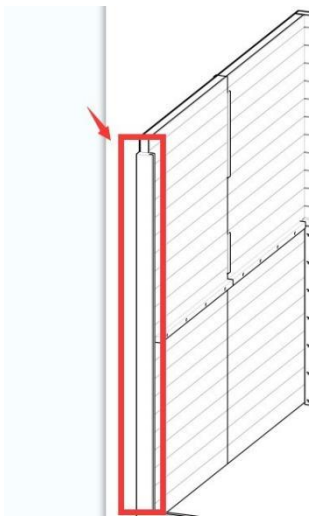

B) Connect the bottom horizontal beam to the vertical beams with the provided screws. Two threaded rods in the hole of bottom beam. You need to use the spanner to screw them.

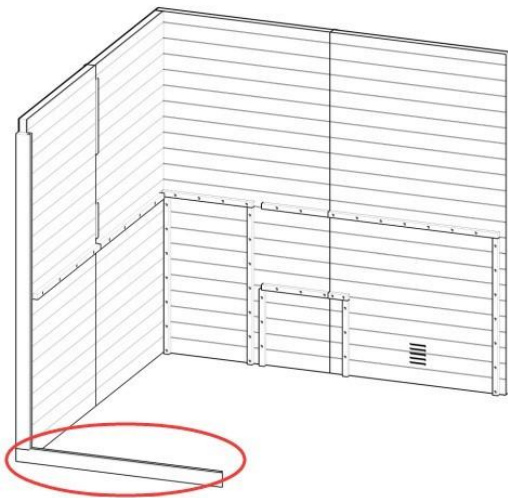

C) Connect the bottom horizontal beams to front panel bottom beam to make them as the completed frame. Use the metal part to fix them tightly by screws 4*25mm.

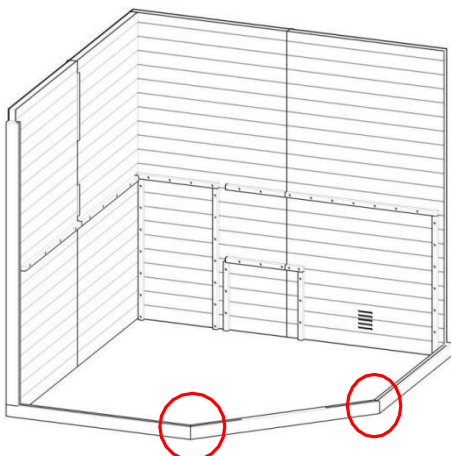

D) Insert the side glass into the slots of the horizontal and vertical beam , then install the Top horizontal beams to fix the glass securely.

EXTREM CAUTION NEEDED TO PROTECT THE GLASS.

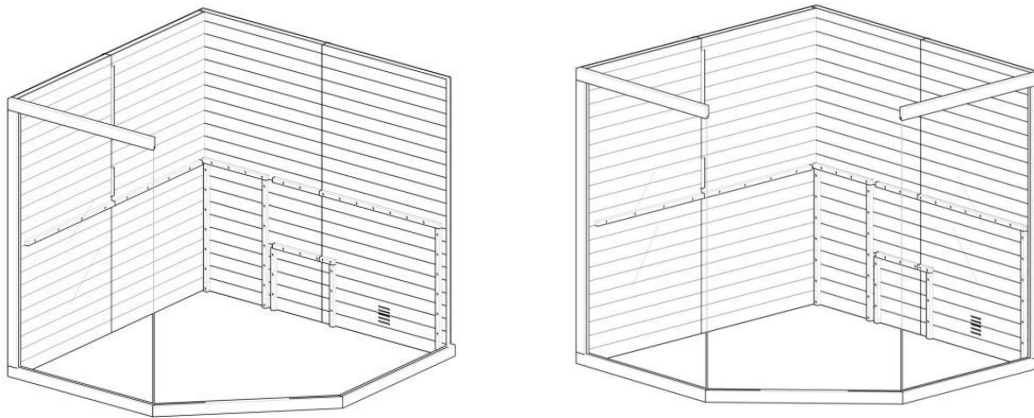

<4> CONNECTING THE FRONT PANEL TO SIDE PANELS

Insert two side glass of the front panel into the slots of the bottom horizontal beam, then install the Top horizontal beams to fix the glass securely. Connect the top horizontal beams by the metal part to fix them tightly by screws 4*25mm.

There is a gap between two glass panels. Pls use the plastic strip to cover the gap between the glasses.

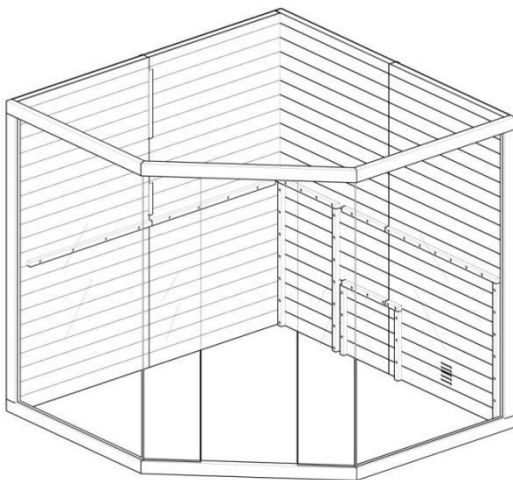

<5> INSTALLING THE BOTTOM PANE

Place the bottom panel on the floor inside the sauna room

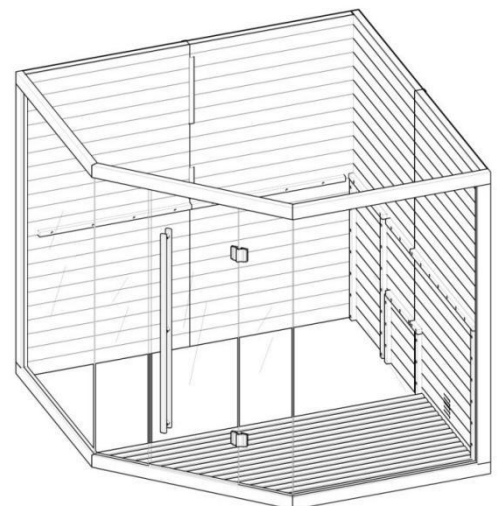
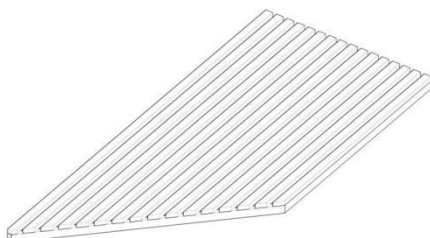

<6> INSTALLING THE LEFT SIDE BENCH SUPPORT

Place the left side bench support and fix it to the back panel by screws (4*40mm)

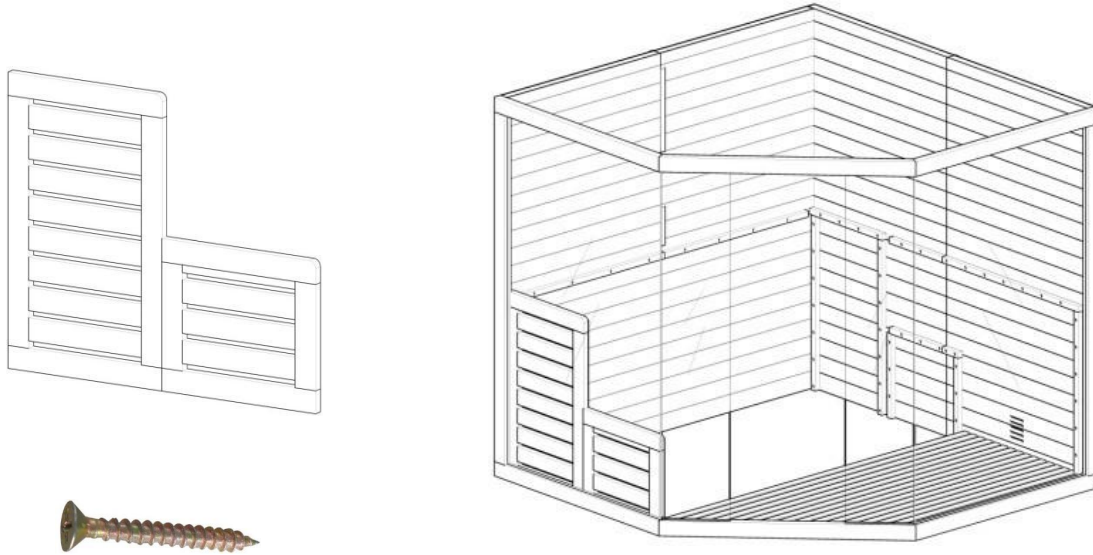

<7> INSTALLING THE LEFT SIDE TWO CALF PANELS

Calf panel should be aligned to the wood beam closely, make sure wood dowels' side is upward, and white plastic nail's side is downward. Fix the calf panel by screws 4*40mm.

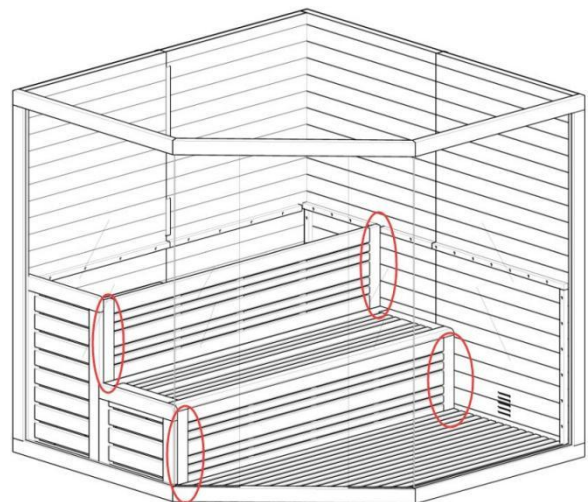
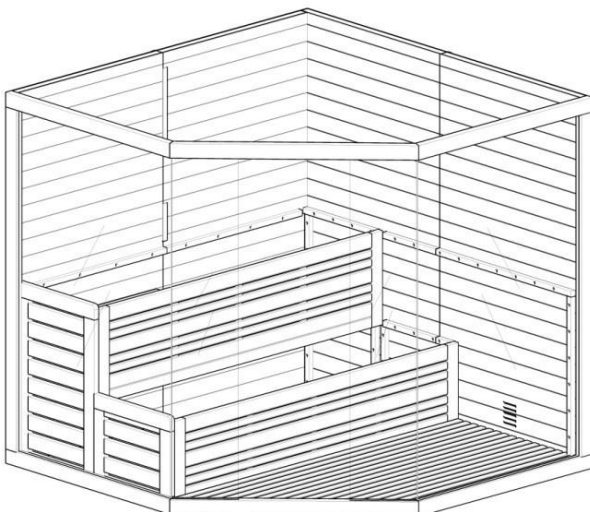

<8> INSTALLING THE RIGHT SIDE BENCH SUPPORT

Place the right side bench support and fix it to the back panel by screws (4*40mm)

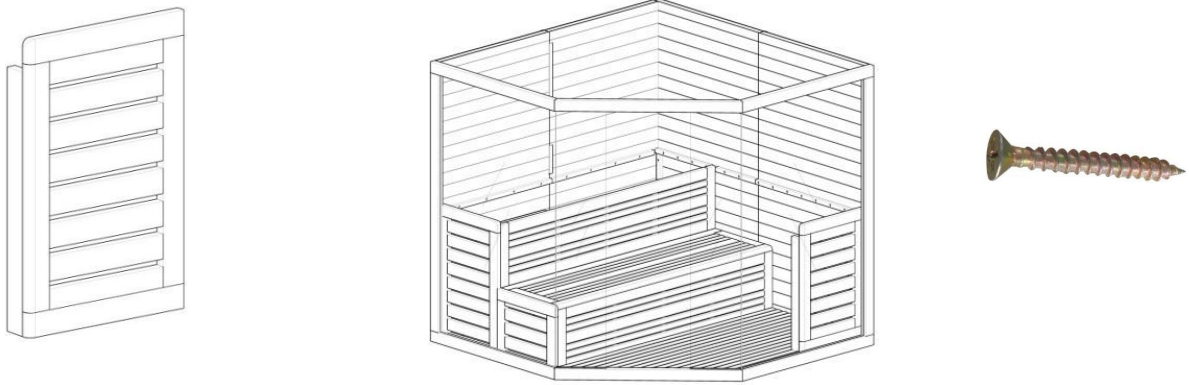

<9> INSTALLING THE WOODEN BEAM OF THE RIGHT SIDE BENCH

Fix this beam by screws (6*55mm)

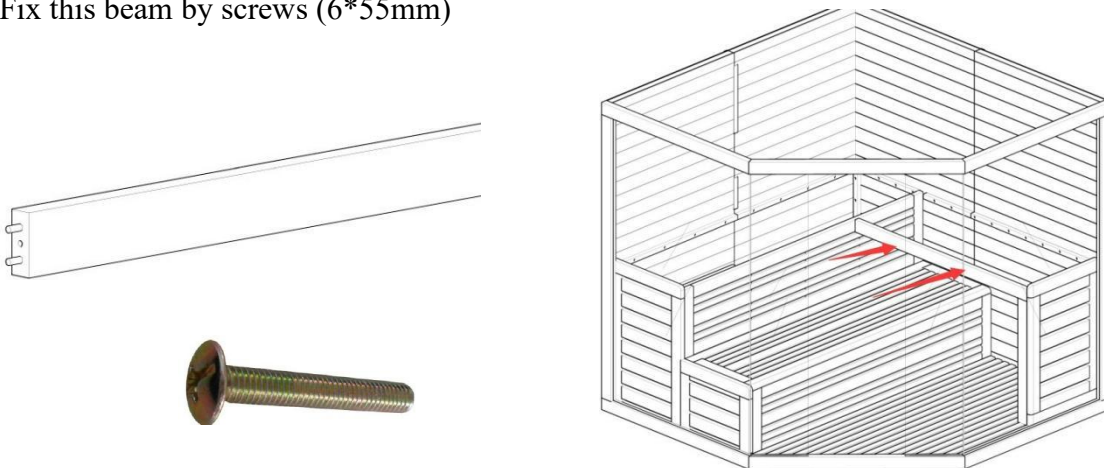

<10> INSTALLING 3 PCS OF TOP BENCHES

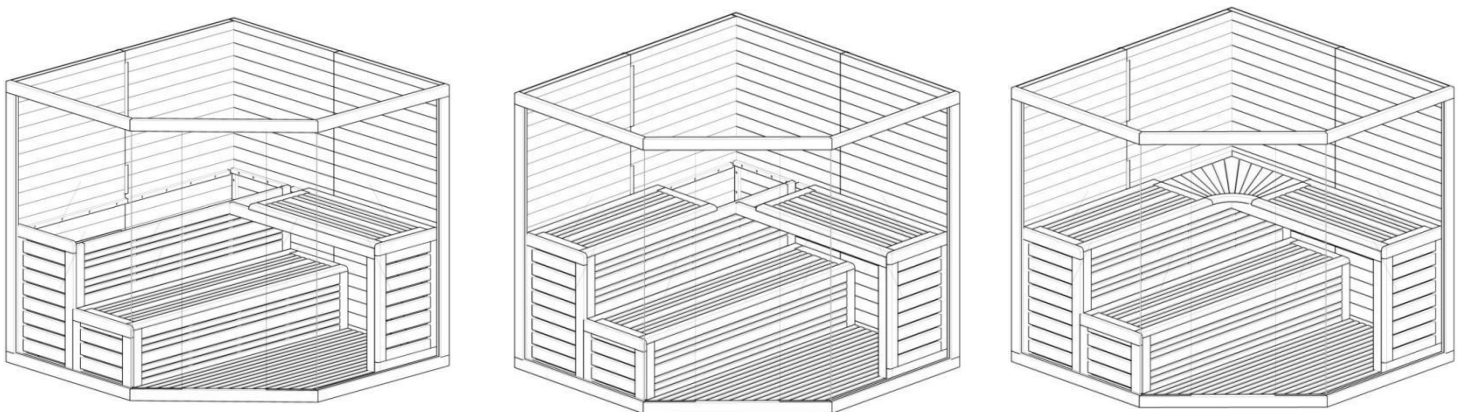

<11> INSTALLING THE BACKREST

1. Please connect two LED color light wires before the installation. **Please pay more attention to the arrows. The arrow toward the arrow.**
2. Screws the backrest to back panel with provided screws 4*40mm

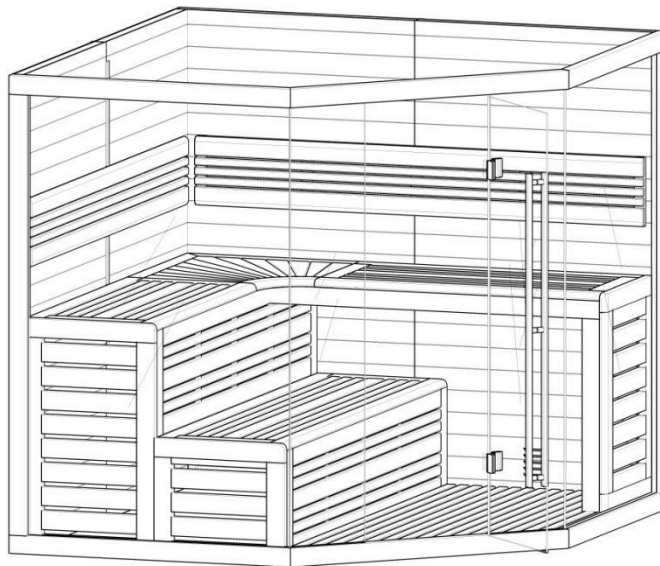
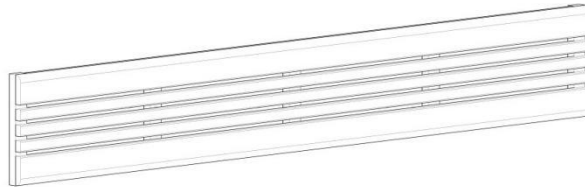

<12> INSTALLING THE LAMP

Connect the cables of the lamp and fix the lamp by screws 4*40mm.



<13> CONNECTING 2 PCS OF ROOF PANEL

Connect these two panels by screws 4*40mm

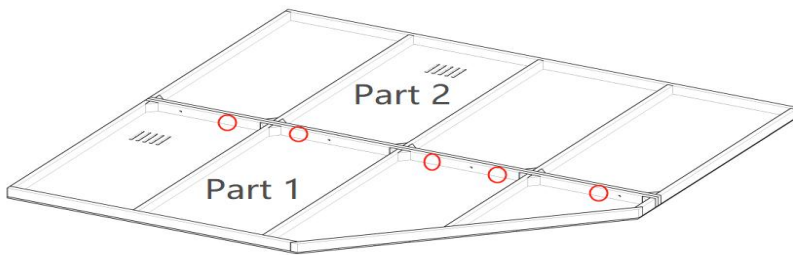

<14> INSTALLING THE ROOF PANEL

1. Lower the top panel onto the assembled panels. Gently place the top panel onto the rest of the assembled panels. When all corners are in place, gently push down the top panel until it is snugly fit over the rest of panels.
2. Connect the wires (**SIX PAIRS**) on the roof with the wires of the light strips. Pls pay attention to arrow toward the arrow on the plugs. Connect the wires on the roof with the wires of the lamp.
3. Fix the roof panels by screws (4*40 mm) to make sure it is stable enough.

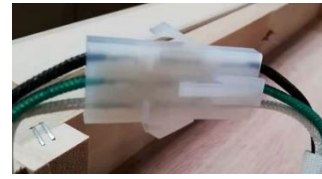
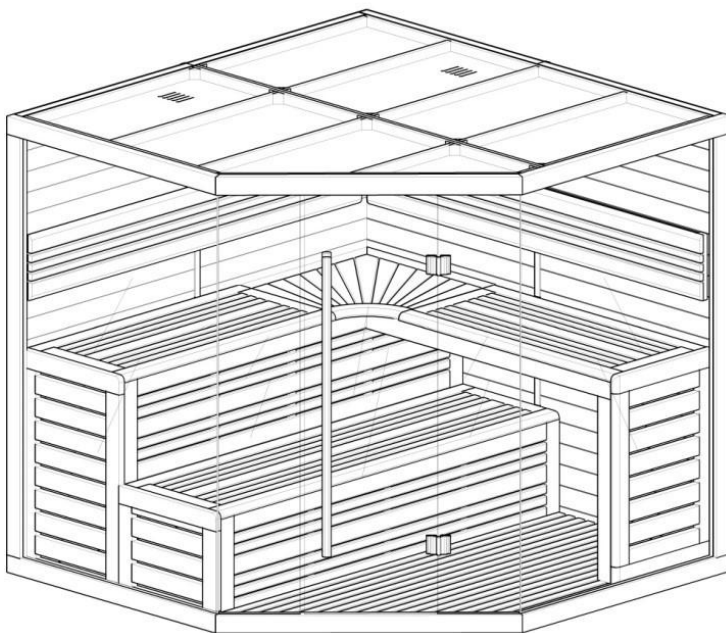

Be sure arrow to arrow when you connect the plugs

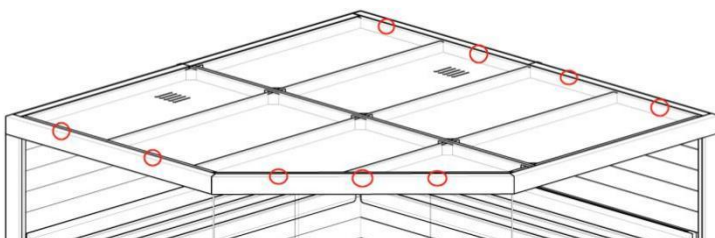
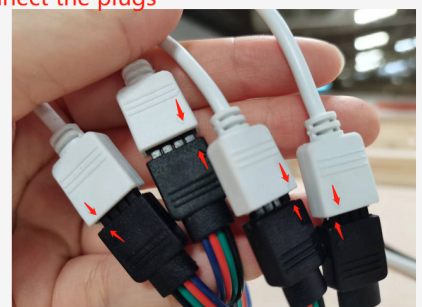

<15> INSTALLING THE FENCE

Install the fence with provided screws 6*35mm

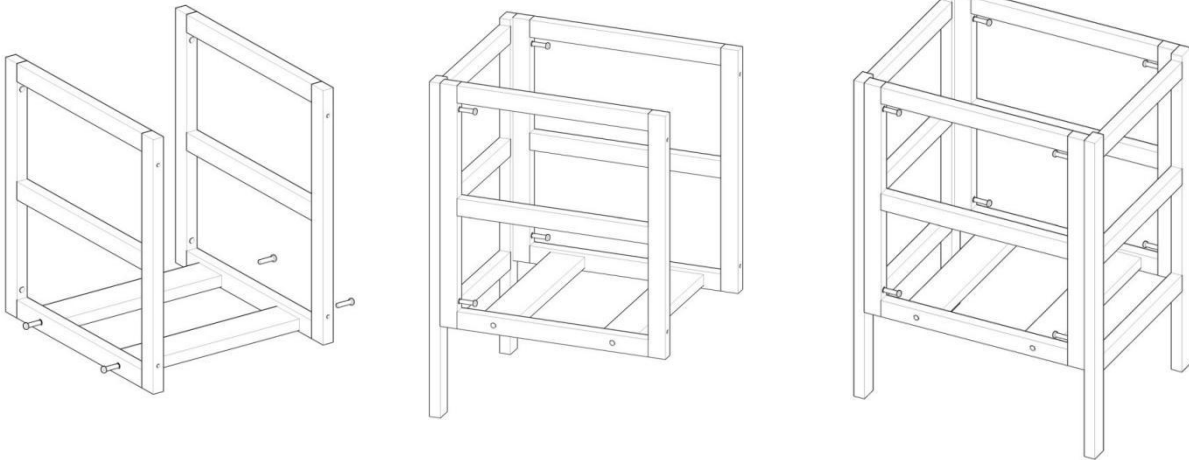

<16> INSTALL THE GLASS DOOR AND DOOR HANDLE

Install the glass door with hinge. **Handle with care!** Try to install the glass door as high as possible to avoid glass door touching bottom problem.



Install the door handle with provided 6*75mm flat head screws



The logo for ALEKO, featuring the word "ALEKO" in white, bold, uppercase letters centered within a solid red square.

Please Read the Following Precautions:

1. Sauna use is not recommended for those that have high blood pressure or heart disease.
2. Sauna use is not recommended for those experiencing a cold.
3. Be alert and aware when using this sauna. Sleeping in the sauna room due to overtiredness is a safety hazard.
4. Sauna use is not recommended on an empty stomach.
5. It is recommended to wait at least 30 minutes after eating to use the sauna.
6. Sauna use is not recommended when intoxicated.
7. Avoid wearing jewelry in the sauna. Stay clear from stones, gems, necklaces, watches, etc.
8. For best results, sauna use is most effective when enjoyed without cosmetics or other pore-blocking agents.
9. Sauna use should be enjoyed in short intervals. Avoid long sauna sessions for safety reasons.
10. Avoid coming into direct contact with cold air after sauna use.
11. Hydration is highly recommended with sauna use.
12. Do not get up too quickly after a sauna session. Get up slowly and restfully.
13. If you experience shortness of breath, dizziness, and other symptoms - immediately stop the sauna, lie down in a better circulated place, and hydrate. If symptoms persist, consult a professional.

ALEKO®

8307 S 192nd St Kent, WA 98032

Phone: 833-926-2323

hello@aleko.com

www.ALEKO.com