

ALEKO®

Barrel Sauna Installation Manual



Instructions before use

1. A member of the high blood pressure, heart disease, high blood pressure do not sauna.
2. Who has a cold should not be sauna because the sauna room hidden cryptococcus bacteria can enter human body through respiratory tract, such as easy to cause pneumonia, etc.
3. Do not sauna when overwork and can't sleep in sauna room. People with poor muscle tone when they are tired, reduce the stimulation of cold and hot resistance ability, easy to cause collapse when sauna.
4. Do not sauna when on an empty stomach, lest cause cardiovascular collapse. Should not be sauna after overstrain brain or strenuous exercise, it can cause brain anemia or shock.
5. It is not suitable for sauna not after half an hour feast, because the high temperature make the skin vasodilation , blood backflow in great quantities, which affects the blood supply of the digestive organs, interfere with digestion and absorption of food.
6. Do not sauna after drinking. After heavy drinking, it can make the brain systems at the mercy of the function to drop, at this time if sauna, under the effect of alcohol, a amount of sweat will make human body caused by rapid filtration syncope.
7. Do not wear jewelry when sauna, like jade, necklaces, watches, etc are easy absorption of heat may be burn the skin.
8. Do not apply cosmetics, because it can block pore, prevent sweat evaporation.
9. Sauna is not suitable for the elderly, sitting in a sauna room, the body sweat more, the blood becomes sticky, it is easy to form thrombus, cause of various cardiovascular diseases. Especially the elderly, their body temperature regulating center not too sensitive, so not suitable for sauna.
10. Sauna should not be too long, if too long, excessive sweating can make the person to exhaustion; temperature is too high, can be difficulty breathing. In general, in the sauna room should be come out every 5-10 minutes. Setting temperature personalized, it is recommended that the dry steam temperature between 60 to 80 make the person feels more moderate.
11. Do not immediately come with cold air after sauna, prevent big difference temperature cause vascular contractions induced stroke.
12. Go with partner sauna, should be timely supplement moisture, do not wait until thirsty to drink.
13. Keep awake when sauna, if have shortness of breath, dizziness and other symptoms should immediately stop sauna, lie down in a better air circulation place, drink some cold boiled water, not drink too low water temperature .
14. Do not get up too fast and too hard, be sure slow up and adequate rest.

Instructions before assembly

1. At least two people are required to assemble the sauna.
2. Assembly location: check whether the ground or platform is horizontal, and slight slope will not affect the assembly and use of sauna, but if the slope is evident, a pad is needed to keep the sauna level.
3. All screw heads to assemble sauna must be completely inserted into wood to avoid scratching skin during use.
4. Please find qualified electricians to install the electrical elements in sauna.

Screw driver (power drill), Tape, Bar level should be prepared by the installers.

Parts list

1. Regular Staves--- 64pcs (31pcs for the right side, 31pcs for the left side).1 pc for each size are spare parts
2. Top stave---2pc (different sizes. only 1pc is required,the other one is spare part)
3. Bottom stave---1pc (with 2 holes)
4. Front and rear sealing parts---7pcs/set * 2
5. Door hinge 2 sets
6. Glass Door 1 pc
7. Door handle 1 set
8. Door locker 1 set
9. Outside bench 2 pcs
10. Outside calf panel 2 pcs
11. Outside floor panel 1 pcs
12. Cradle base 1 set
13. Inside floor panel
14. Bench support 6 pcs
15. Heater fence 1 set
16. Inside calf panel 2 pcs
17. Backrest 2 pcs
18. Lamp 1 set
19. Front panel part---3pcs
20. Back panel part---3pcs
21. Triangle wooden piece ----2pcs
22. Water bucket---1pc, Sand Timer---1pc , Ladle---1pc Hygrometer – 1pc
23. Sauna stone – 1 box
24. Steel strip ----3sets
25. Screws--- 1 bag
- 26.Bitumen roof--1 set

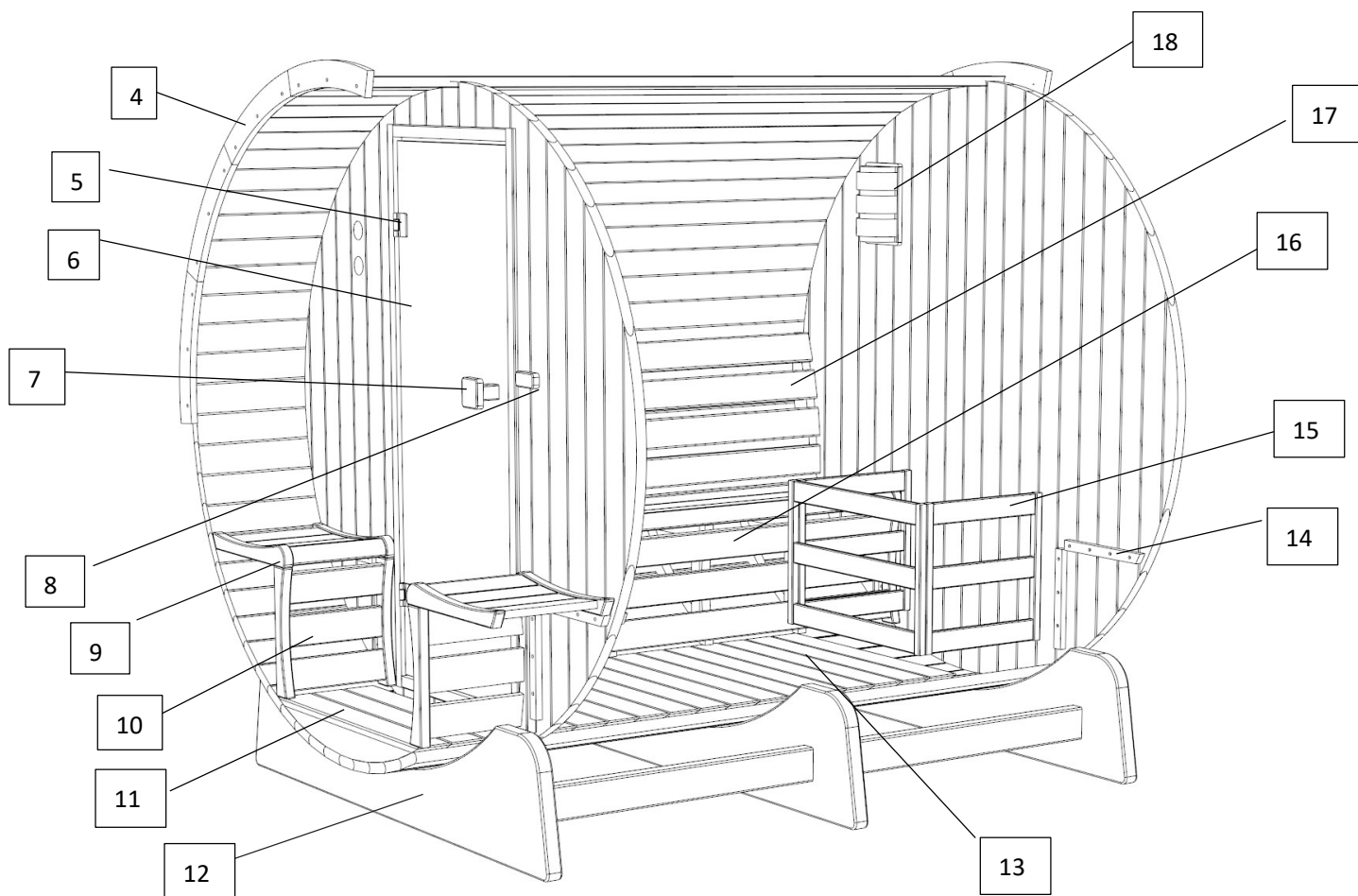

- 1.Regular Staves
- 2.Top stave
- 3.Bottom stave
- 4.Front and rear sealing parts
- 5.Door hinge
- 6.Glass door
- 7.Door handle
- 8.Door locker
- 9.Outside bench
- 10.Outside calf panel
- 11.Outside floor panel
- 12.Cradle base
- 13.Inside floor panel
- 14.Bench support
- 15.Heater fence
- 16.Inside calf panel
- 17.Backrest
- 18.Lamp

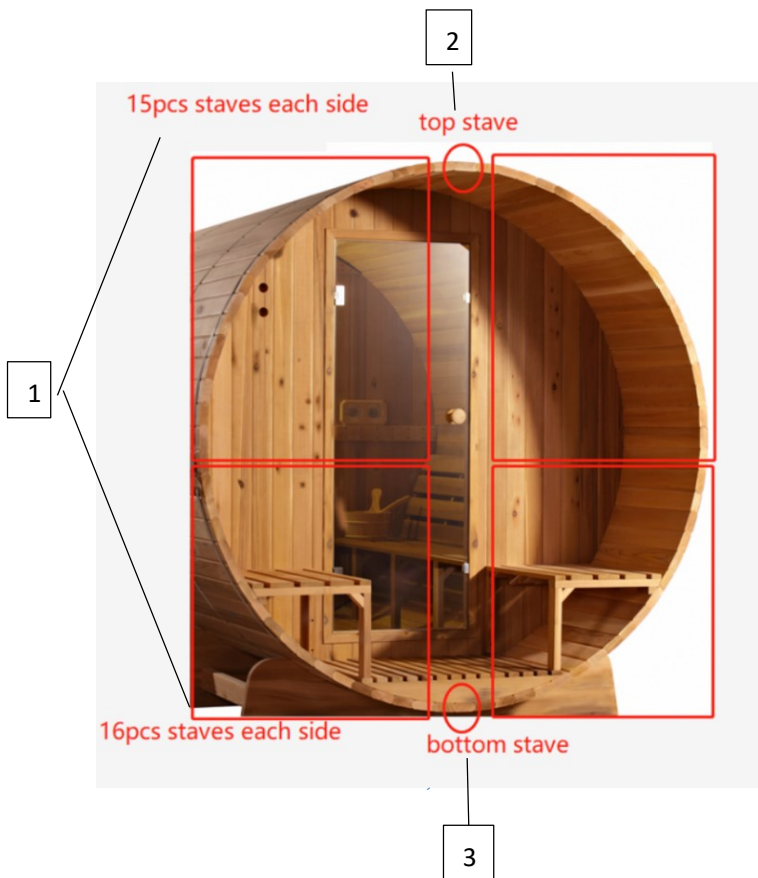

FIRST CONSIDERATIONS

When you begin the initial layout for assembly, it is very important to check your floor or deck to see if it is level. Most garage floors, basement floors, and decks are sloped for drainage. If this is the case in your installation, it is suggested that you use shims to make the sauna level. Failure to do this can result in unplumbed panels, poor fit and or poor function of your sauna.

OUTDOOR INSTALLATION RECOMMENDATIONS

Take caution to prevent the wind from catching and breaking the glass door.

NOTE: While your Barrel Sauna is designed for outdoor use, it is important to build the sauna in accordance with these instructions to minimize water seepage into the sauna. Properly installed, water will not drip into the sauna. However, over time water may seep between the staves due to the porous nature of softwood. This will not hurt the sauna and will quickly evaporate once the sauna heater is turned on. If the water proofing is desired, shingles or other roofing material can be installed on the top section of the Barrel Sauna.

1. Base installation:

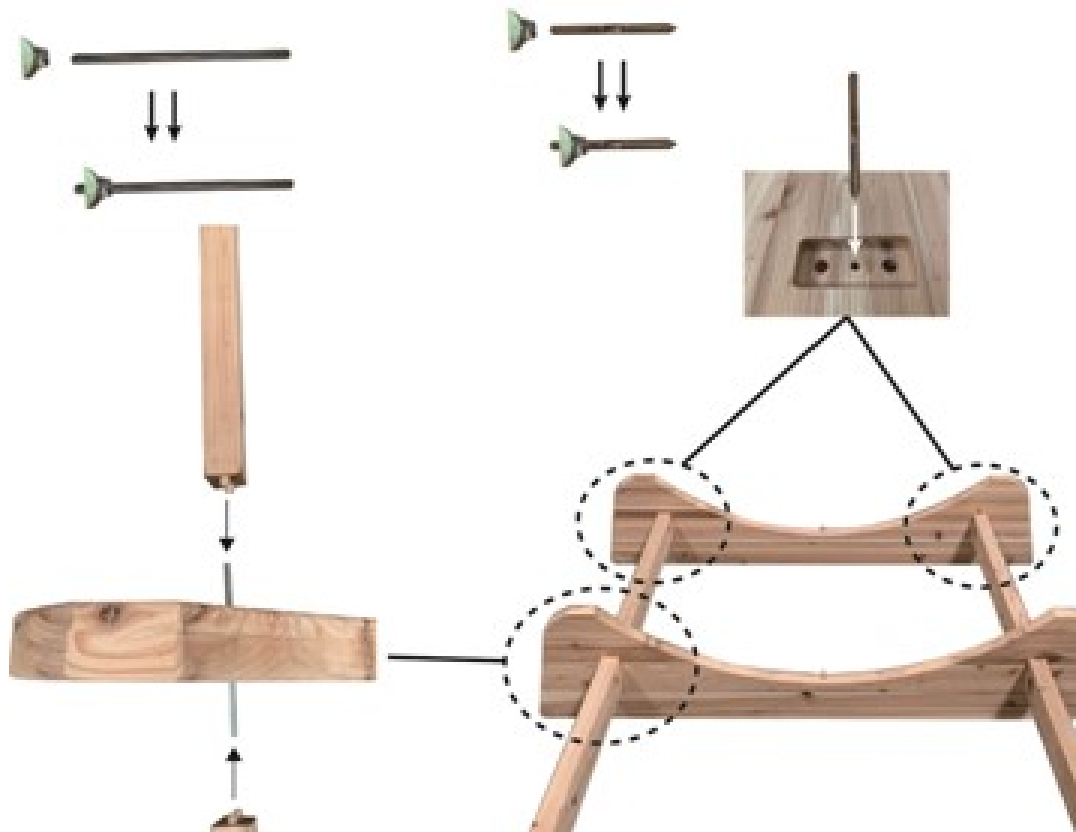

2. Match the 3pcs wooden dowel with the 3 holes on the bottom stave and place the bottom stave in the middle of the base. Screw the bottom stave into the cradle base supports using 3 X 4*40mm screws.



3. Place 7pcs additional staves on each side of the drain stave to each end of the cradle base. Use a rubber hammer to gently tap the staves together. Use 42pcs 4*40mm screws to fix the 14pcs stave on 3 bases.

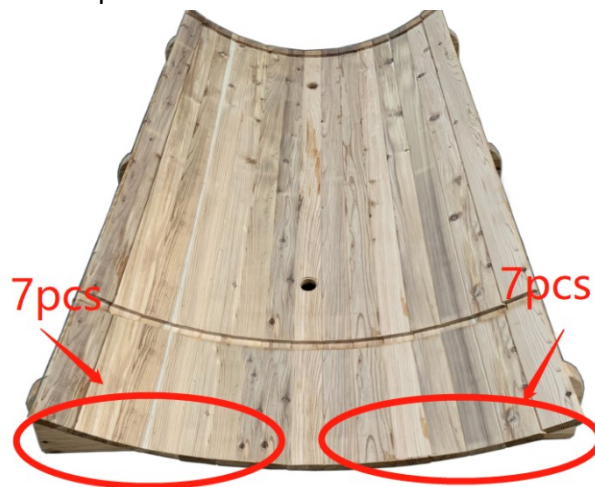

4. Back panel assembly with screws provided.

Screws size: 5*70mm *4pcs



5. Front panel assembly with screws provided. Screws size: 5*70mm * 4pcs



6. Place the back panel and front panel on the base.

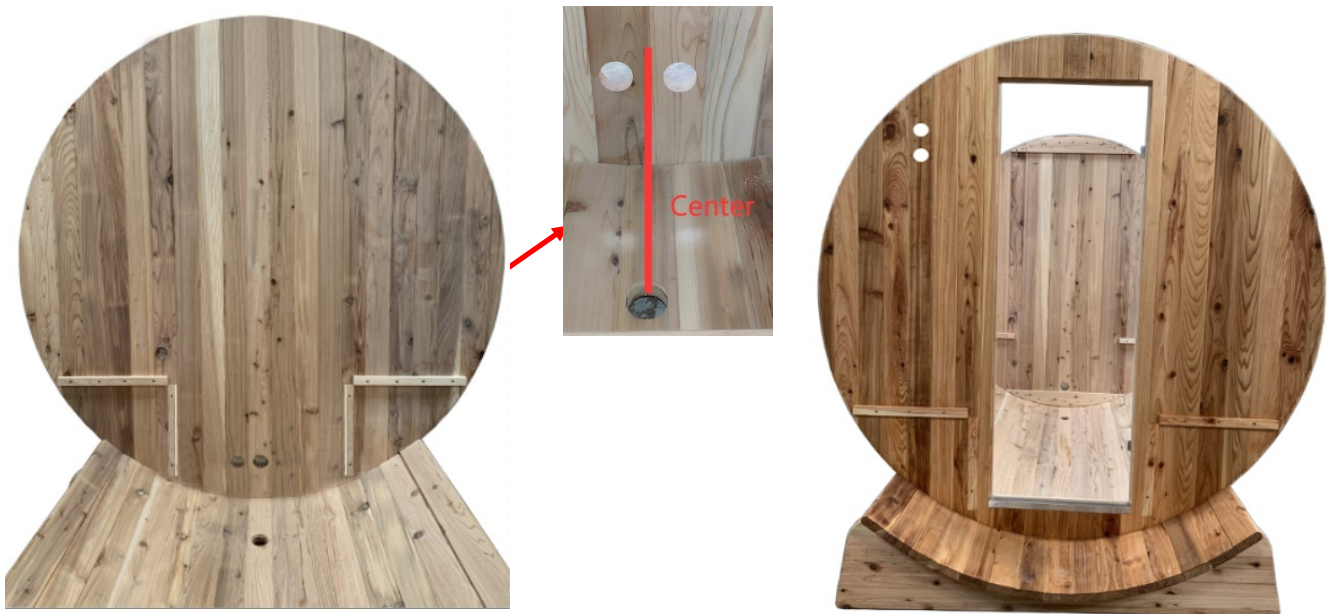

7. Place additional 9pcs staves on each side of the barrel. Use 36pcs 4*40mm screws to fix the 18pcs staves to the front & back panel.

8. Install the 15pcs staves on each side forwards the top BUT DO NOT WITH SCREWS!!!!. Use rubber hammer to make sure all the staves are installed tightly.

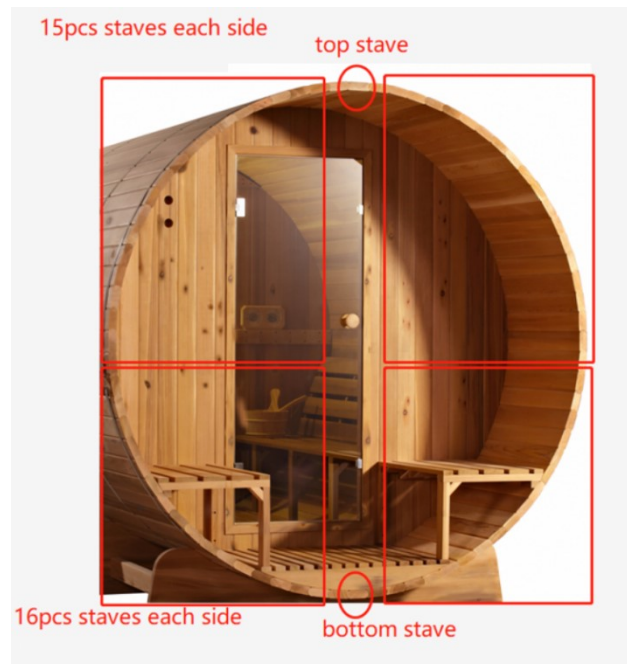

9. The remaining gap will be filled with the 'Top Final Stave' which is available in two sizes. Due to natural swelling/shrinking of the cedar wood, one piece is likely to fit better than the other. Choose the one that fits best.



Place the stave into the gap by lifting the surrounding pieces upwards to create a small arch. Gently push down and use a rubber mallet lightly to tap into place.

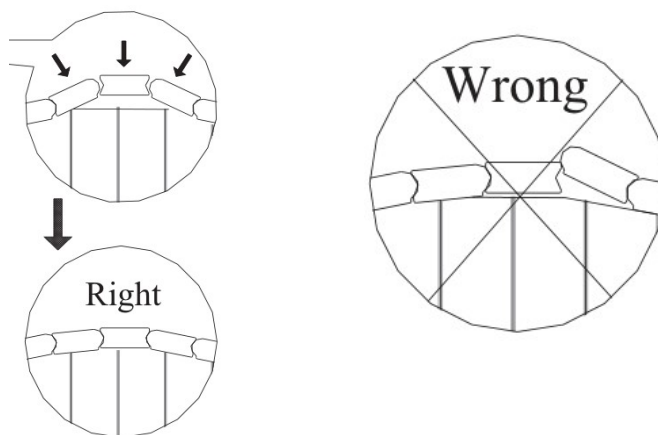

After the top piece is correctly installed, fix the remaining staves with 4*40mm screws.

10. Install the glass door, door handle and the door locker unit.



11. Steel strip assembly --- **Caution! Sharp Edge! Protective gloves needed. Pls refer to Steel strip assembly manual.**

Each of the steel strip assemblies are made of the following components:

- (1) stainless steel bands with brackets (3 pcs)
- (2) Nuts (6 pcs)
- (3) threaded rod (3 pcs)

Place stainless steel bands with pre-assembled brackets around sauna, spaced evenly apart. The two end stainless steel bands should cover the nails you used to hold the staves in place during assembly. Insert threaded rod through the bracket. Tighten nuts evenly so that the bands are of equal tension. Before tightening nuts, check to make sure bands are still even. Tighten nuts and install black vinyl thread protectors. You may place the brackets at the same level or vary them at different heights depending on our styling preference.

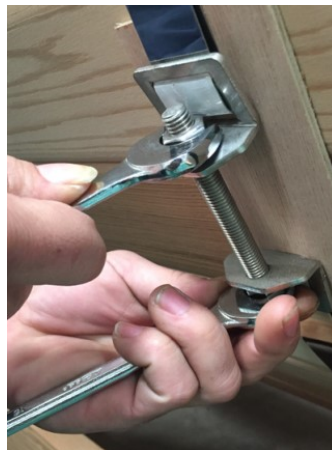
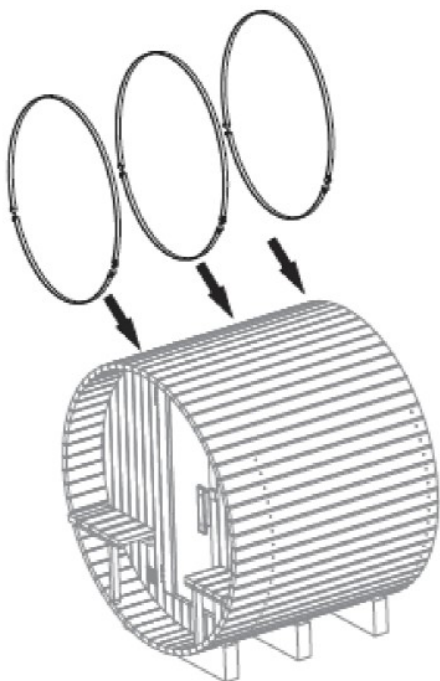

11. Inside bench assembly.

A. Install the bench support (fan shaped frame) to the barrel, make sure all are at the same level.



B. Fix the bench support to the barrel by screws (2pcs 4*40mm).



C. Fix the bench to the bench support by screws (2pcs 4*40mm).

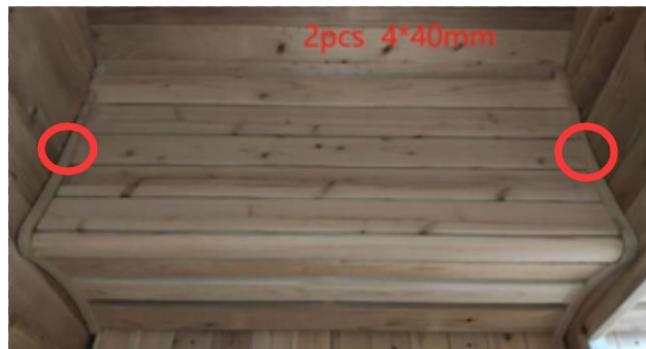

12. Outside bench assembly

A. Fix the bench support to the barrel by screws (2pcs 4*40mm).

B. Fix the bench to the bench support by screws (2pcs 4*40mm).



13. Place the 3pcs floors and fix them with screws (6pcs 4*40mm).



Outside



Inside

14. Heater Fence Assembly: 4pcs 6*35mm flathead screws needed.

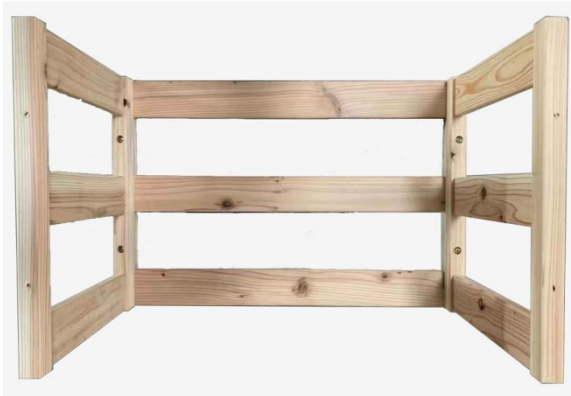

15. Heater Assembly : pls refer to the manufacturer's instructions. After heater installation, pls fix the heater fence to the wall with 4pcs 4*40mm sharpen head screws.

16. Install the lamp, lamp holder on the back panel.

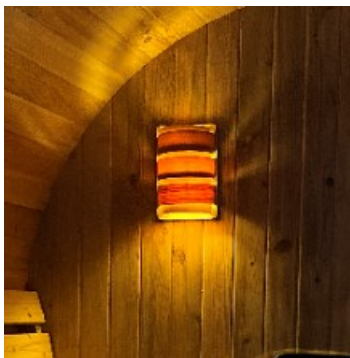

17. Install the front & back cover (3*30mm screws).

The center of the cover must match the center of the barrel.



One Top piece (no wooden dowel)

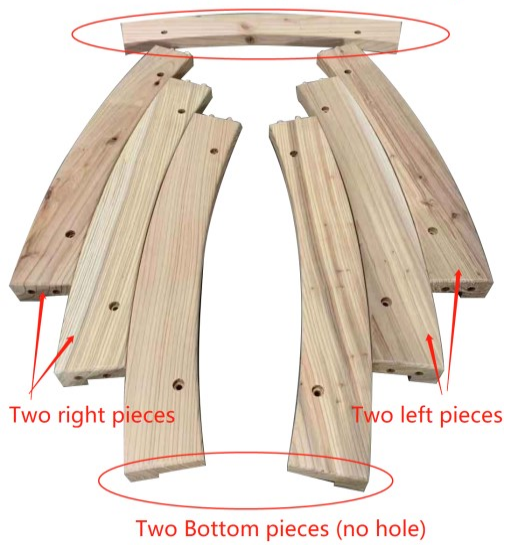

18. Install the triangle wood piece to the barrel with 3*30mm screws at both sides.



19. Install the wooden piece at the center of the holes of the front panel by screw

Screw: 1pc 3*25mm



20. Install the Bitumen Roof. Bitumen Roof layout for Barrel Sauna size:81*73 inch

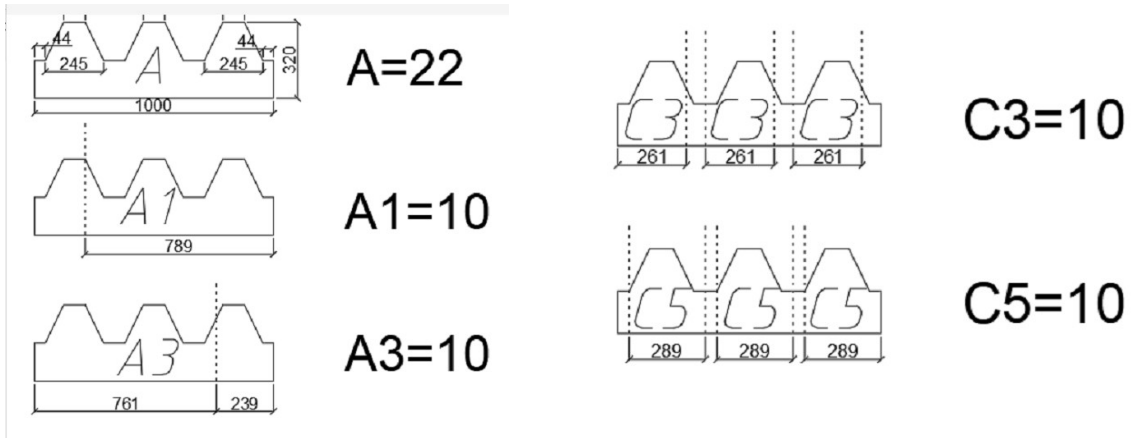

- A -- 22 Pcs
- A1-- 10 Pcs
- A3-- 10 Pcs
- C3-- 10 Pcs
- C5-- 10 Pcs

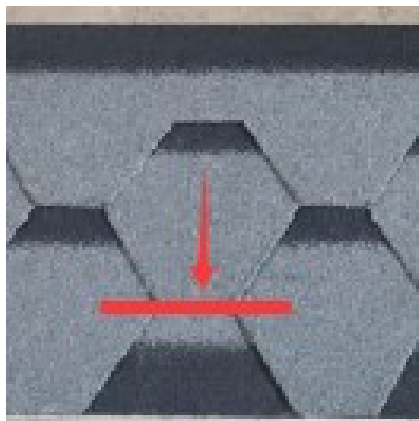

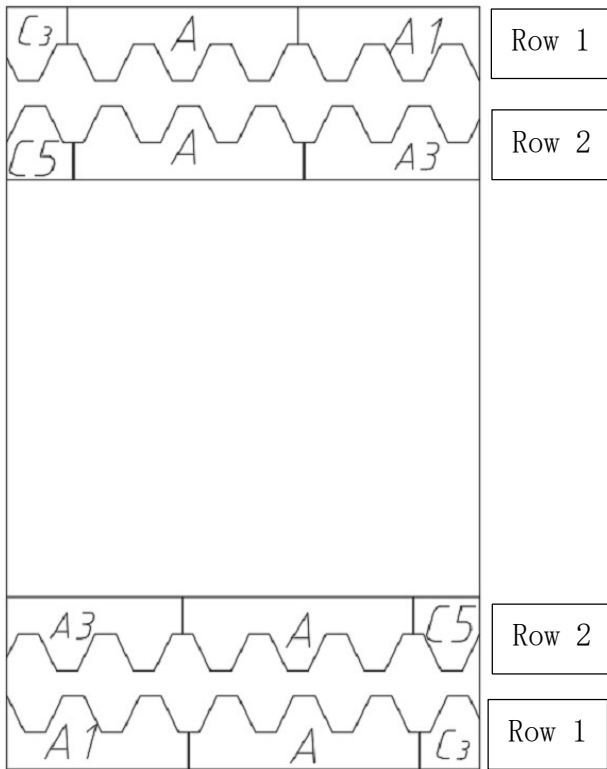

Left Row 1= C_3+A+A_1
 Left Row 2= C_5+A+A_3

Right Row 2= A_3+A+C_5
 Right Row 1= A_1+A+C_3

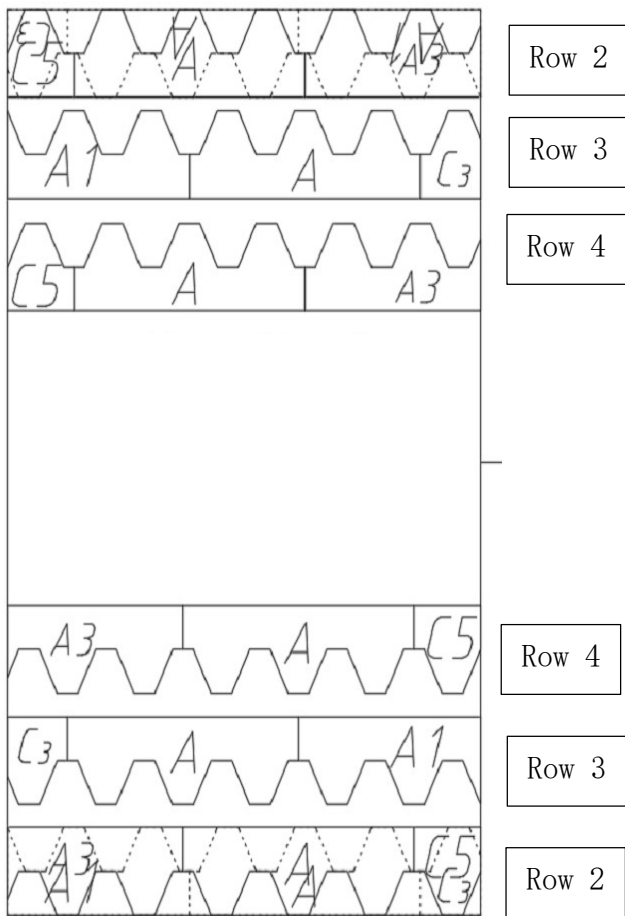

Left Row 2= C_5+A+A_3
 Left Row 3= A_1+A+C_3
 Left Row 4= C_5+A+A_3

Right Row 4= A_3+A+C_5
 Right Row 3= C_3+A+A_1
 Right Row 2= A_3+A+C_5

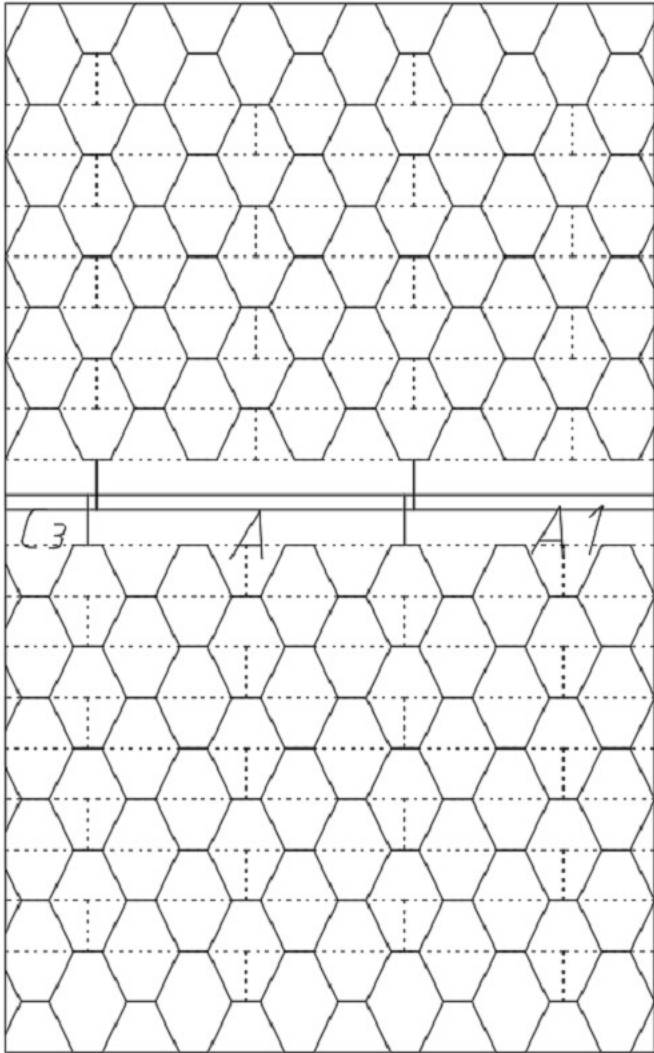

$$\begin{aligned} & \cdot C5+A+A3 \\ & \cdot A1+A+C3 \\ & \cdot C5+A+A3 \\ & \cdot A1+A+C3 \\ & \cdot C5+A+A3 \\ & \cdot A1+A+C3 \\ & \cdot C5+A+A3 \\ & \cdot C5+A+A3 \end{aligned}$$

$$= C5+A+A3$$

$$= C3+A+A1$$

$$= A3+A+C5$$

$$\cdot C3+A+A1$$

$$\cdot A3+A+C5$$

$$\cdot C3+A+A1$$

$$\cdot A3+A+C5$$

$$\cdot C3+A+A1$$

$$\cdot A3+A+C5$$

$$\cdot C3+A+A1$$

$$\cdot A3+A+C5$$

$$\text{Left Row 2} = C5+A+A3$$

$$\text{Left Row 3} = A1+A+C3$$

$$\text{Left Row 4} = C5+A+A3$$

$$\text{Left Row 5} = A1+A+C3$$

$$\text{Left Row 6} = C5+A+A3$$

$$\text{Left Row 7} = A1+A+C3$$

$$\text{Left Row 8} = C5+A+A3$$

$$\text{Left Row 9} = A1+A+C3$$

$$\text{Left Row 10} = C5+A+A3$$

$$\text{Right Row 11} = C3+A+A1$$

$$\text{Right Row 10} = A3+A+C5$$

$$\text{Right Row 9} = C3+A+A1$$

$$\text{Right Row 8} = A3+A+C5$$

$$\text{Right Row 7} = C3+A+A1$$

$$\text{Right Row 6} = A3+A+C5$$

$$\text{Right Row 5} = C3+A+A1$$

$$\text{Right Row 4} = A3+A+C5$$

$$\text{Right Row 3} = C3+A+A1$$

$$\text{Right Row 2} = A3+A+C5$$

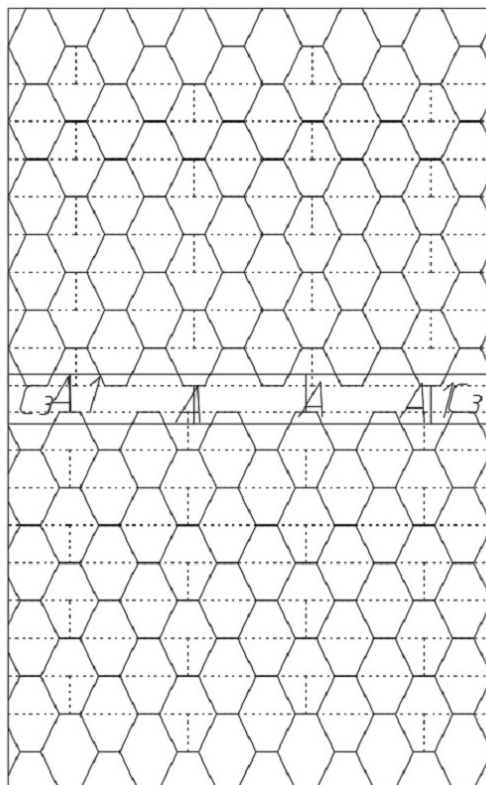

Bitumen Roof layout for Barrel Sauna size:65*73 inch

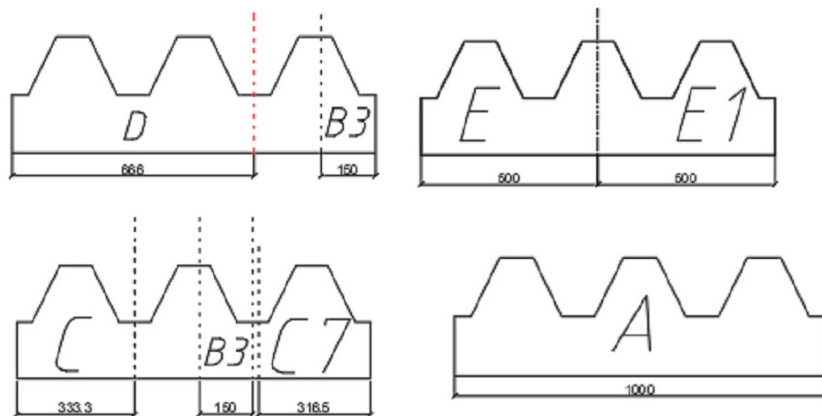

- A -- 22 Pcs
- B3-- 10 Pcs
- D--- 2 Pcs
- C---10 Pcs
- C7-- 10 Pcs
- E-- 10 Pcs

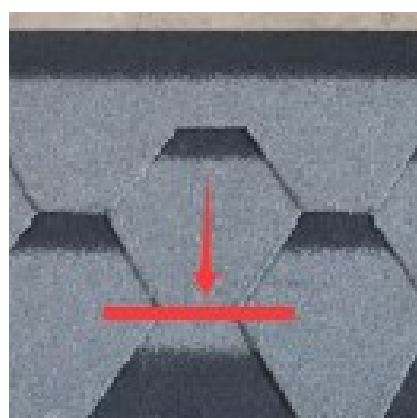

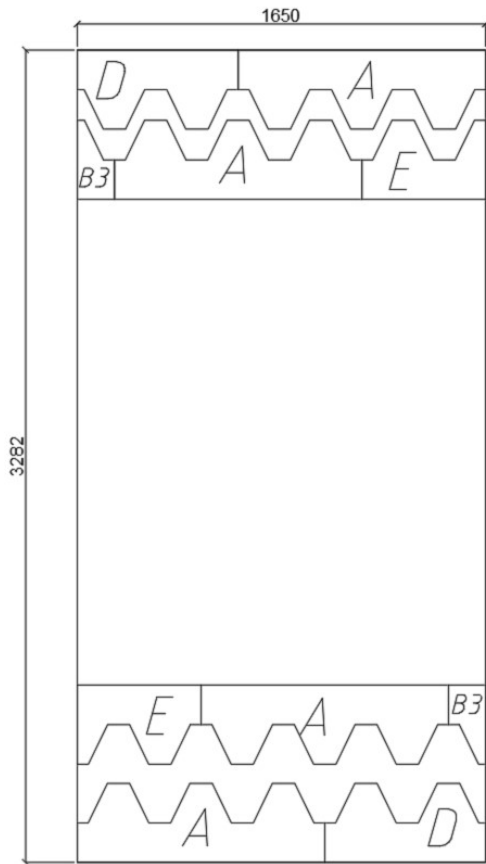

Row 1

$$\text{Left Row 1} = D + A$$

Row 2

$$\text{Left Row 2} = B3 + A + E$$

Row 2

$$\text{Right Row 2} = E + A + B3$$

Row 1

$$\text{Right Row 1} = A + D$$

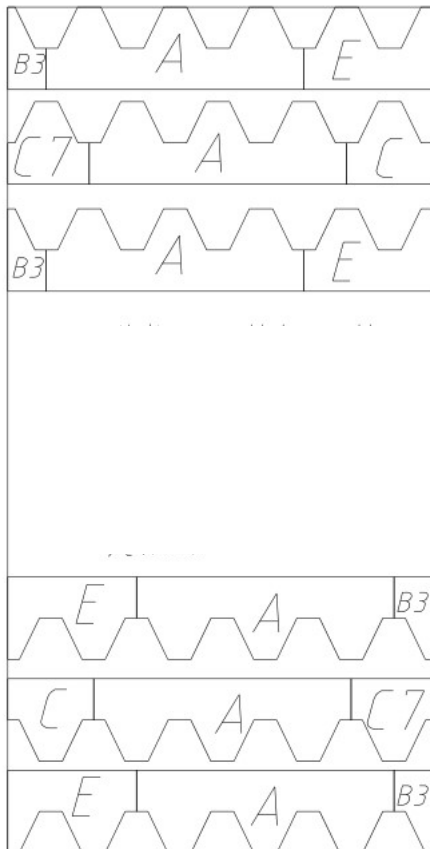

Row 2

$$\text{Left Row 2} = B3 + A + E$$

Row 3

$$\text{Left Row 3} = C7 + A + C$$

Row 4

$$\text{Left Row 4} = B3 + A + E$$

Row 4

$$\text{Right Row 4} = E + A + B3$$

Row 3

$$\text{Right Row 3} = C + A + C7$$

Row 2

$$\text{Right Row 2} = E + A + B3$$

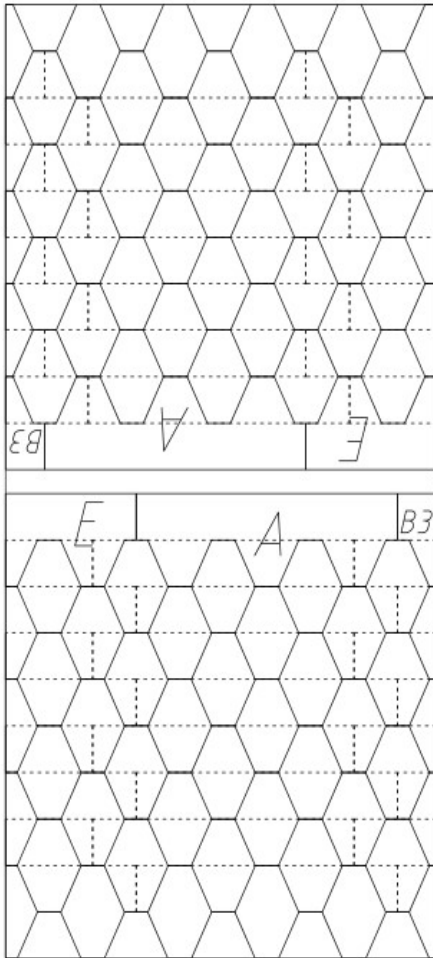

Left Row 2= $B3+A+E$
 Left Row 3= $C7+A+C$
 Left Row 4= $B3+A+E$
 Left Row 5= $C7+A+C$
 Left Row 6= $B3+A+E$
 Left Row 7= $C7+A+C$
 Left Row 8= $B3+A+E$
 Left Row 9= $C7+A+C$
 Left Row 10= $B3+A+E$

Right Row 10= $E+A+B3$
 Right Row 9= $C+A+C7$
 Right Row 8= $E+A+B3$
 Right Row 7= $C+A+C7$
 Right Row 6= $E+A+B3$
 Right Row 5= $C+A+C7$
 Right Row 4= $E+A+B3$
 Right Row 3= $C+A+C7$
 Right Row 2= $E+A+B3$

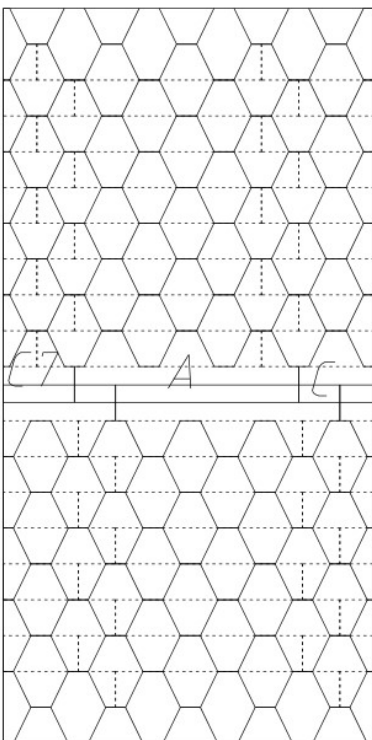

Left Row 11:
 $C7+A+C$

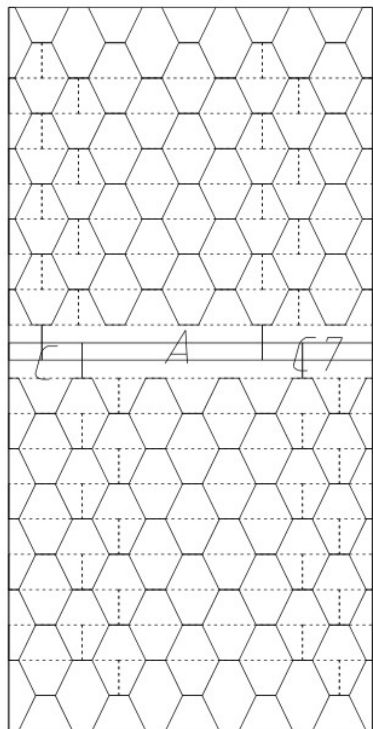

Right Row 11:
 $C+A+C7$

Bitumen Roof layout for Barrel Sauna size:91*73 inch

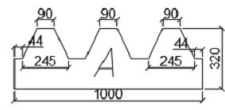

A=22

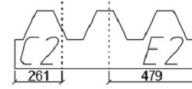

E2=10 C2=10



A5=12

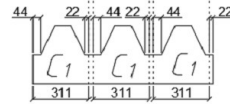

C1=2

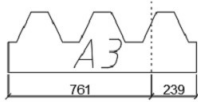

A3=10

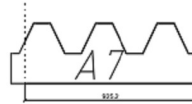

A -- 22 Pcs

A5-- 10 Pcs

A3--- 10 Pcs

E2---10 Pcs

C2-- 10 Pcs

C1- 2 Pcs

A7--2 Pcs

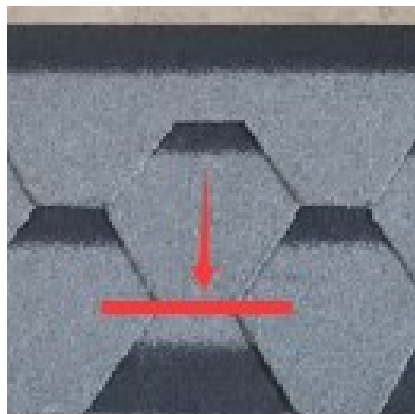

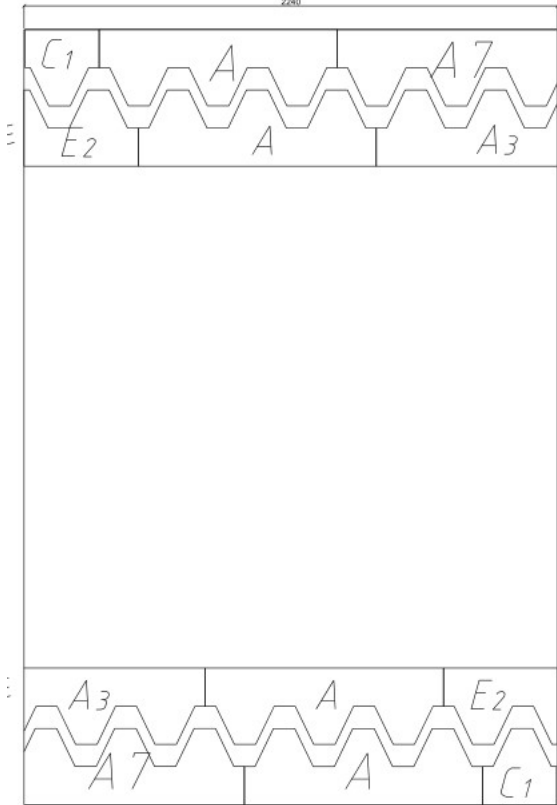

Row 1

Left Row 1= $C1+A+A7$
Left Row 2= $E2+A+A3$

Row 2

Row 2

Right Row 2= $A3+A+E2$
Right Row 1= $A7+A+C1$

Row 1

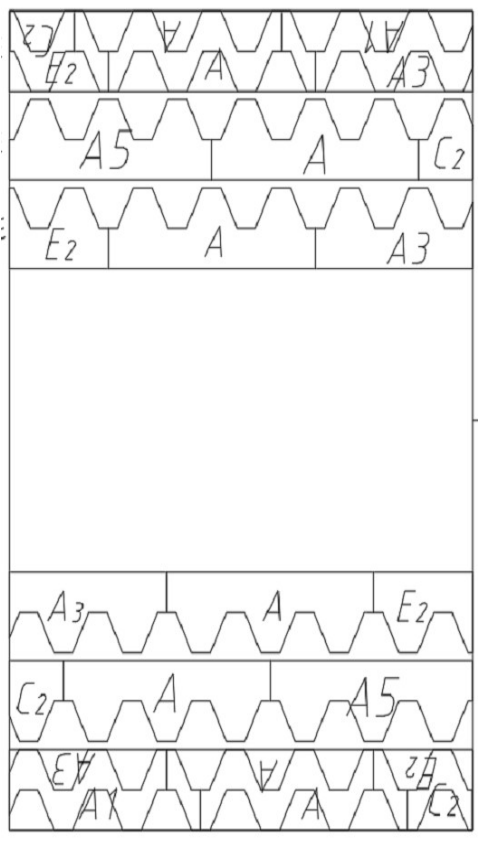

Row 2

Left Row 2= $E2+A+A3$
Left Row 3= $A5+A+C2$
Left Row 4= $E2+A+A3$

Row 3

Row 4

Row 4

Right Row 4= $A3+A+E2$
Right Row 3= $C2+A+A5$
Right Row 2= $A3+A+E2$

Row 3

Row 2

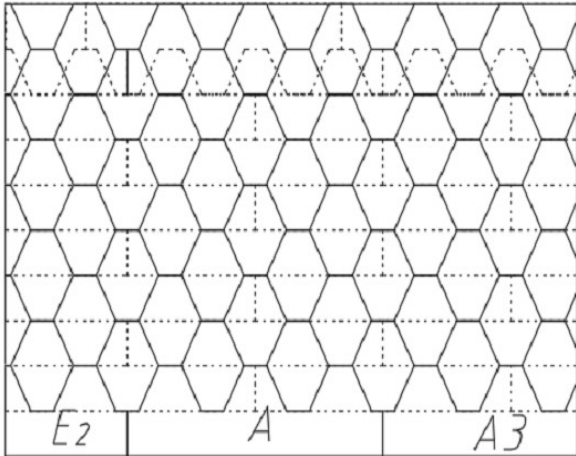

$E2+A+A3$
 $A5+A+C2$
 $E2+A+A3$
 $A5+A+C2$
 $E2+A+A3$
 $A5+A+C2$
 $E2+A+A3$
 $A5+A+C2$
 $E2+A+A3$
 $A5+A+C2$

Left Row 2= $E2+A+A3$
 Left Row 3= $A5+A+C2$
 Left Row 4= $E2+A+A3$
 Left Row 5= $A5+A+C2$
 Left Row 6= $E2+A+A3$
 Left Row 7= $A5+A+C2$
 Left Row 8= $E2+A+A3$
 Left Row 9= $A5+A+C2$
 Left Row 10= $E2+A+A3$

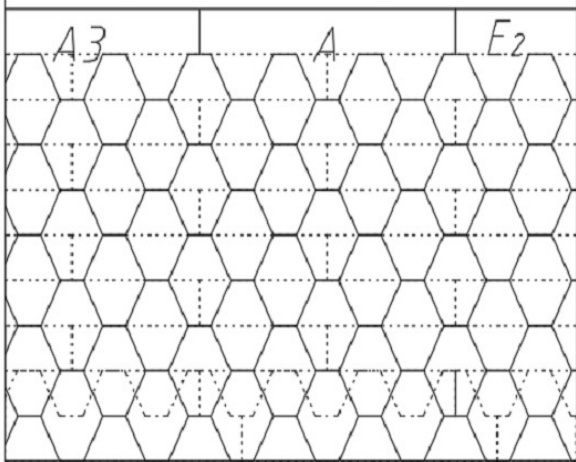

$A3+A+E2$
 $C2+A+A5$
 $A3+A+E2$
 $C2+A+A5$
 $A3+A+E2$
 $C2+A+A5$
 $A3+A+E2$
 $C2+A+A5$
 $A3+A+E2$

Right Row 10= $A3+A+E2$
 Right Row 9= $C2+A+A5$
 Right Row 8= $A3+A+E2$
 Right Row 7= $C2+A+A5$
 Right Row 6= $A3+A+E2$
 Right Row 5= $C2+A+A5$
 Right Row 4= $A3+A+E2$
 Right Row 3= $C2+A+A5$
 Right Row 2= $A3+A+E2$

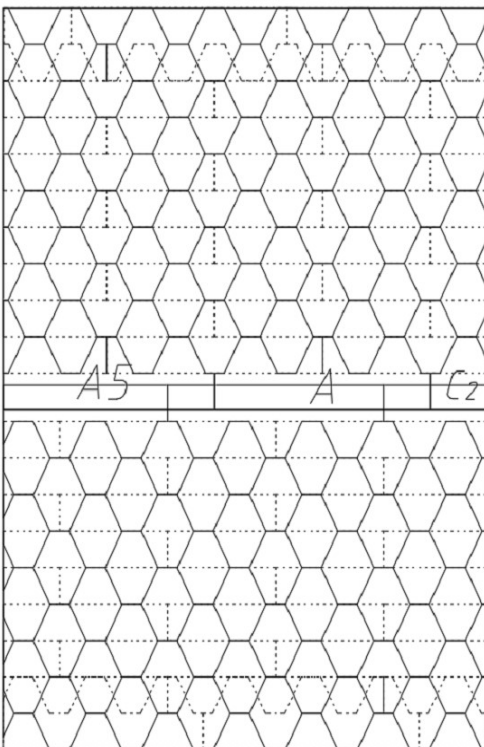

Left Row 11:
 $A5+A+C2$

Right Row 11:
 $C2+A+A5$

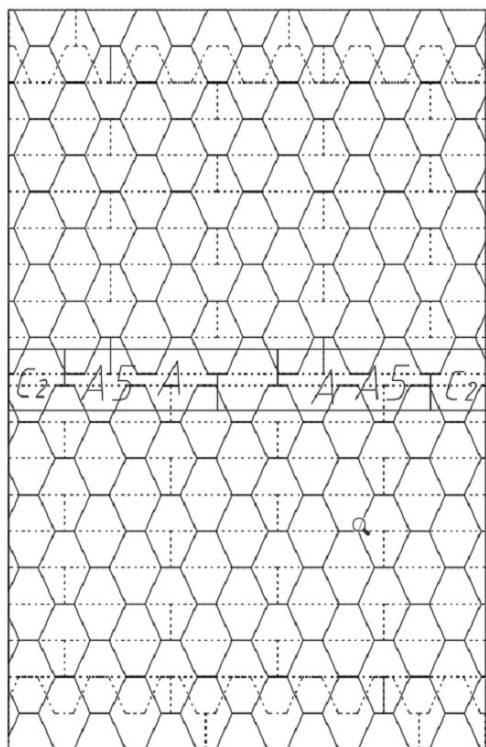

ALEKO®

8307 S 192nd St Kent, WA 98032

Phone: 833-926-2323

hello@aleko.com

www.ALEKO.com