

# Sliding Gate Opener User's Manual

**Model:**

**AR500NOR-M**

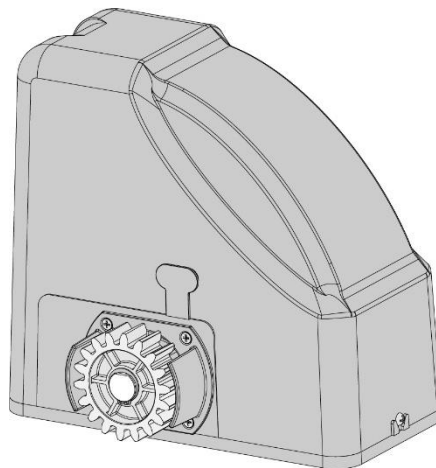

- ★ Please read and follow all warnings, precautions and instructions before installation and use.
- ★ Periodic checks of the opener are required to ensure safe operation.
- ★ For residential use only
- ★ Save this manual.

[www.Aleko.com](http://www.Aleko.com)

# Table of Contents

General Safety .....	1
Preparation for Installation .....	2
Parts List.....	3
Optional Accessories Parts List.....	3
Technical Specifications & Features .....	4
Installation Overview .....	5
Installation of the Opener .....	5
Manual Operation.....	6
Fit the Plastic Rack Reinforced with Steel .....	6
Installation of the Magnets .....	7
Connection of the Power Supply.....	7
Connecting Of the Control Board.....	9
Setting Of the Control Board .....	11
Test the reversing sensitivity .....	13
How to learn or erase the remote .....	13
How to use the remote to control the opener.....	13
Troubleshooting.....	14
Maintenance .....	15

Thank you for purchasing our sliding gate opener. We are sure that the products will be greatly satisfying as soon as you start to use it.

The product is supplied with a user's manual which encloses installation and safety precautions. These should be read carefully before installation and operation as they provide important information about safety, installation, operation and maintenance. This product complies with the recognized technical standards and safety regulations.

## General Safety



**WARNING!** An incorrect installation or improper use of the product can cause damage to persons, animals or properties.

- Scrap packing materials (plastic, cardboard, polystyrene etc.) according to the provisions set out by current standards. Keep nylon or polystyrene bags out of children's reach.
- This product was exclusively designed and manufactured for the use specified in the present documentation. Any other use not specified in this documentation could damage the product and be dangerous.
- The factory declines all responsibility for any consequences resulting from improper use of the product, or use which is different from that expected and specified in the present documentation.
- Do not install the product in explosive atmosphere.
- The factory declines all responsibility for any consequences resulting from failure to observe Good Technical Practice when constructing closing structures (door, gates etc.), as well as from any deformation which might occur during use.
- Disconnect the electrical power supply before carrying out any work on the installation. Also disconnect any buffer batteries, if fitted.
- Fit an omnipolar or magnetothermal switch on the mains power supply, having a contact opening distance equal to or greater than 3,5 mm.
- Make sure a residual current circuit breaker with a 30mA threshold is fitted before the power supply mains.
- Check that earthing is carried out correctly: connect all metal parts for closure (doors, gates etc.) and all system components provided with an earth terminal.
- Fit all the safety devices (photocells, electric edges etc.) which are needed to protect the area from any danger caused by squashing, conveying and shearing.
- Position at least one visible indication device, and fix a Warning sign to the structure.

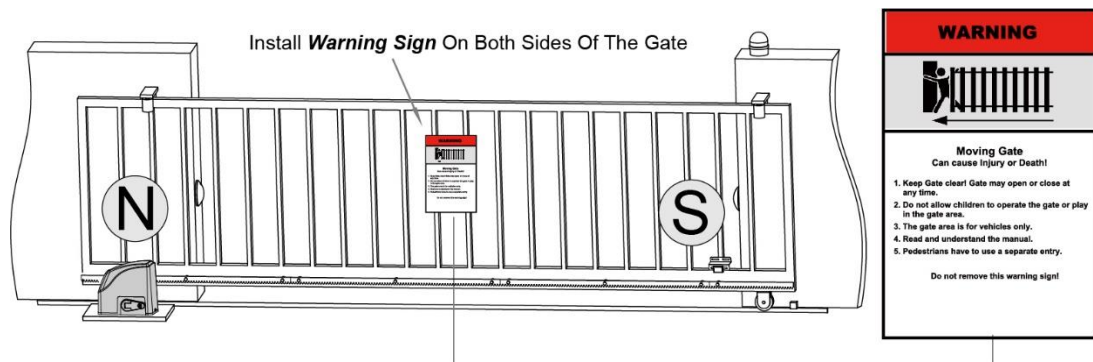

- The factory declines all responsibility with respect to the automation safety and correct operation when other supplier's components are used.
- Only use original parts for any maintenance or repair operation.
- Do not modify the automation components, unless explicitly authorized by the factory.
- Instruct the product user about the control systems provided and the manual opening operation in case of emergency.

- Do not allow persons or children to remain in the automation operation area.
- Keep radio control or other control devices out of children's reach, in order to avoid unintentional automation activation.
- The user must avoid any attempt to carry out work or repair on the automation system, and always request the assistance of qualified personnel.
- Anything which is not expressly provided for in the present instructions is not allowed.
- Before installing the gate opener, check that all moving part as well as the sliding gate is in good mechanical condition, correctly balanced and opens and closes properly.
- Save these instructions for future use.

## Preparation for Installation

Before proceeding to your opener installation, check if your gate structure is in accordance with the current standards, especially as follows:

The gate sliding track is linear and horizontal, and the wheels are suitable, the gate should be mounted and moving freely. Check that the structure is sufficiently strong and rigid, Make sure that the gate is plumb and level. The fence posts must be mounted in concrete. The gate does not bind or drag on the ground.

- The opening and closing gate stops are positioned.



**WARNING:** Remember that control devices are intended to facilitate gate operation, but can not solve problems due to any defects or deficiency resulting from failure to carry out correct installation or maintenance. Take the product out of its packing and inspect it for damage. Should it be damaged, contact your dealer. Remember to dispose of its components (cardboard, polystyrene, nylon, etc.) according to the current prescriptions.

Refer to the following Figures for gate installation.

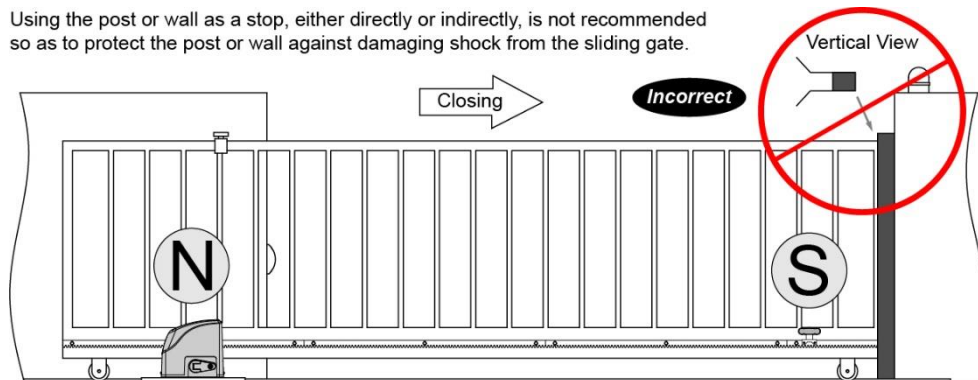



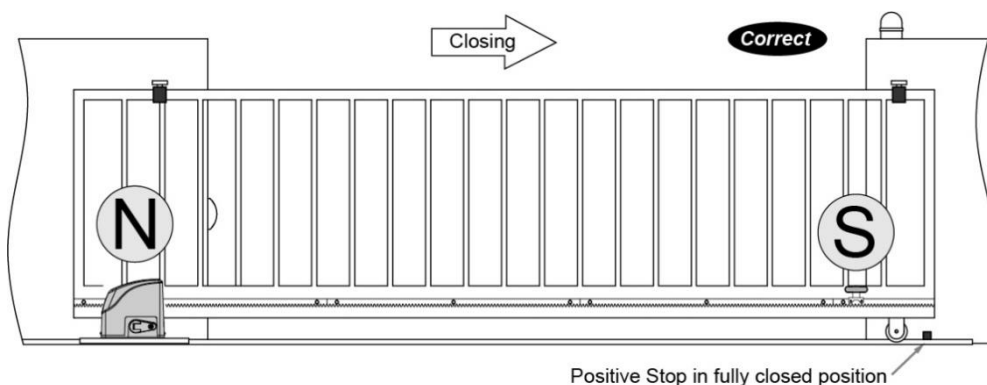

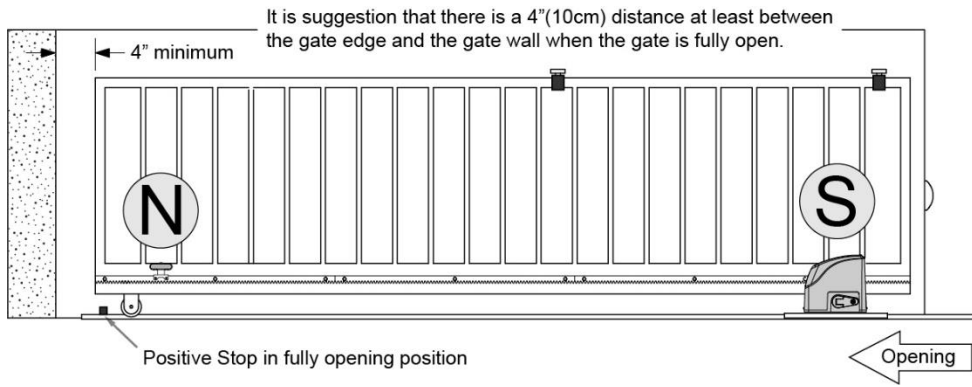



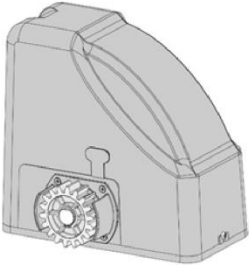

In sake of safety, a positive stop must be mounted on the two end of ground track.





















## Parts List

 <p>Gate Opener (1 pc)</p>	 <p>Remote Control (2 pcs)</p>	 <p>Expansion Tube 12X60 (4 pcs)</p>	 <p>Warning Signs (2 pcs)</p>	
	 <p>Big Washer <math>\Phi 8</math> (4 pcs)</p>	 <p>Hex self-tapping screw M8X60 (4 pcs)</p>		
 <p>Release Key (2 pcs)</p>	 <p>Magnet Assembly (N pole) (1 pc)</p>	 <p>Magnet Assembly (S pole) (1 pc)</p>	 <p>Magnet Bracket (2 pcs)</p>	 <p>Pan Head Screw M5×12 (8 pcs)</p>

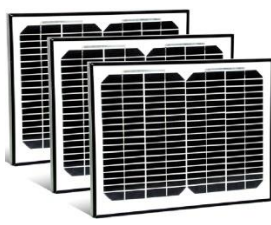
## Optional Accessories Parts List

 <p>Back-up Battery</p>	 <p>Back-up Battery Box</p>	 <p>Wall Push Button</p>	 <p>Wireless Push Button</p>
 <p>External Receiver</p>	 <p>Wireless Keypad</p>	 <p>Universal Wireless and Wired Keypad</p>	 <p>Wired Keypad</p>

 Reflection Photocell Sensor	 Photo Eye Beam Sensor	 24V Alarm Lamp	 Vehicle Sensor Exit Wand
 Solar Controller	 Mounting Post for Keypad	 30W Solar Panel Kit	 Plastic Rack
 Heavy Duty Gear Rack	 Light Duty Gear Rack		

## Technical Specifications & Features

Specifications	
	AR500NOR-M
Power input:	110-120V~, 60Hz
Motor voltage:	24VDC
Rated power:	180W
Gate moving speed:	21 cm/s (8.3 in/s)
Max gate weight:	600kg (1300lbs)
Environmental conditions:	-22°C ~ +55°C (-4°F to 122°F)
Protection class:	IP44

### Features:

- Midway mode.
- Quick selection for the gate open/close direction
- Reliable rolling code technology for remote control
- Emergency release key in case of power failure
- Stop in case of obstruction during gate opening
- Reverse in case of obstruction during gate closing
- Built in adjustable auto-close (none, 30, 60, 90

seconds)

- Built in max. Motor Running Time (MRT) for multiple safety protection (90 seconds)
- Reliable electromagnetism limit for easy adjustment
- Can be equipped with a wide range accessories
- Easy to install, and minimum maintenance requirement

# Installation Overview

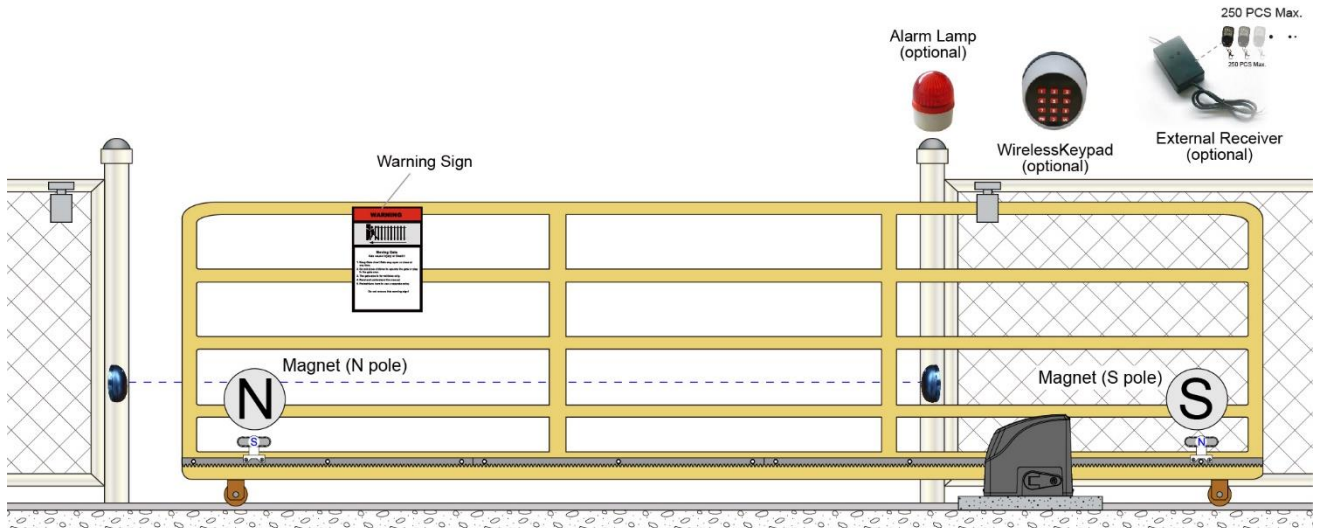

## Installation of the Opener

### Caution:

\*Be sure that the opener is installed in a level and paralleled position and is properly secured. Improper installation could result in property damage, severe injury, and/or death.

\* Before starting installation, ensure that there is no point of friction during the entire movement of the gate and there is no danger of derailment.

\* Ensure that the safety side panels are present.

**Necessary Tools:** The following tools may be necessary to install the Gate opener. Screwdrivers, an electric hammer, wire cutters and a wire stripper, a socket set.

When install the opener, you should have or build a concrete pad to support the base plate of opener in order to maintain proper stability.

### The installation proceeds are as follows:

1. Dig a hole for a concrete pad which should be approximately 40 x 24 x 30cm (16"x 9.5"x 12"). It may protrude 10 cm (4") above ground and 20 cm (8") in depth underground. Increase the pad height if necessary to protect the system from flooding, heavy snow etc.

2. Prepare one or more conduits for the electrical cables before pour concrete. Remember that

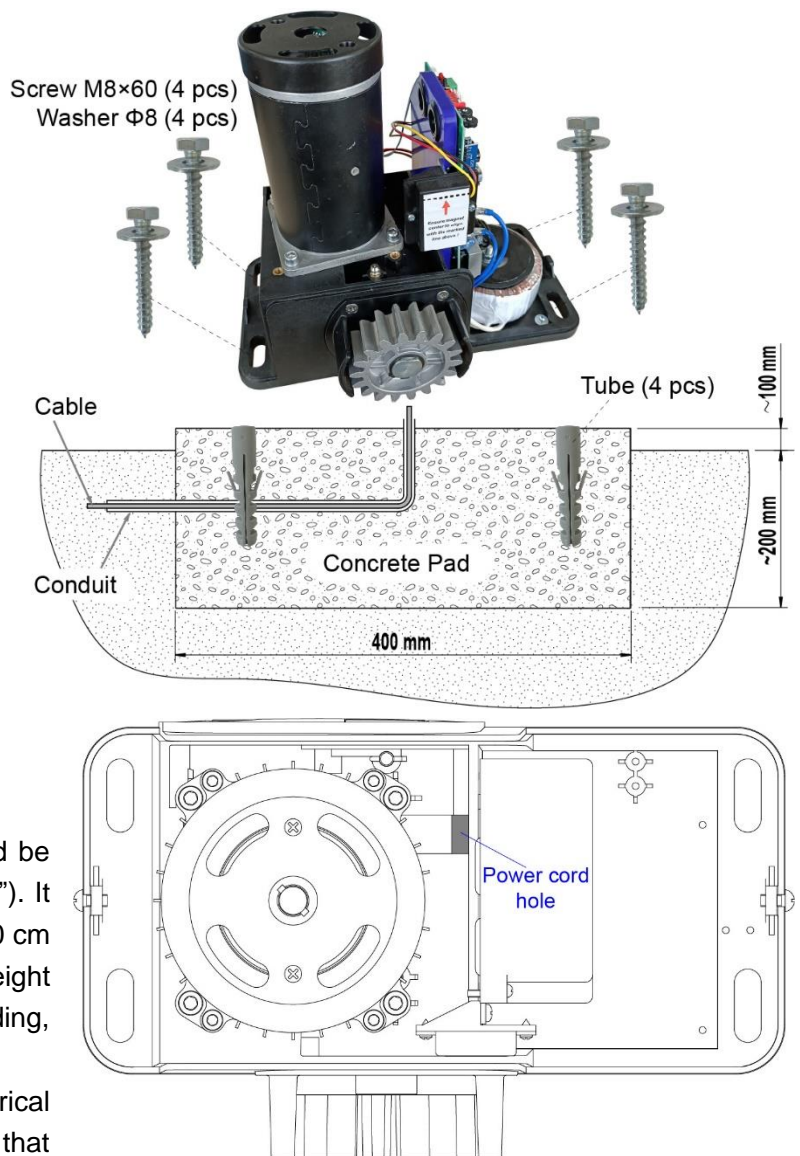

cable conduits have to pass through the hole in opener base.

3. Pour concrete and before it starts to harden, check that it is parallel to the gate leaf and perfectly level.
4. Make sure the position of Expansion Tubes was placed according to the position of mounting holes on the opener base.
5. Mount the opener to the concrete Pad. It's only temporary installation. Further adjustment will be required when install the rack.

## Manual Operation

You can open the gate by manual when power failure. And the opener should be put in the manual (emergency release) position before fitting the rack, installing the opener and limit switch. The process is as follows:

Insert the Release Key and turn it in clockwise 90°, then pull the release handle in clockwise 90° to disengage the clutch between the gear shaft and motor. Now the opener is in the manual operation.



## Fit the Plastic Rack Reinforced with Steel

1. Start with gate in closed position
2. Rack is optional. 1 piece is 1 meter. You can order from the dealer if needed.
3. Put one end of rack section on the gear of opener as a temporary support. Make rack level and mark the rack's mounting holes (**four holes for light duty or six holes for heavy duty**) on the gate.
4. Fit the rack by self-threading screws. This kind of plastic rack is quieter and allows height adjustments to be made even after it has been fixed. Please keep 1.0mm space between the rack and the gear to avoid the weight of the gate effect on the opener.

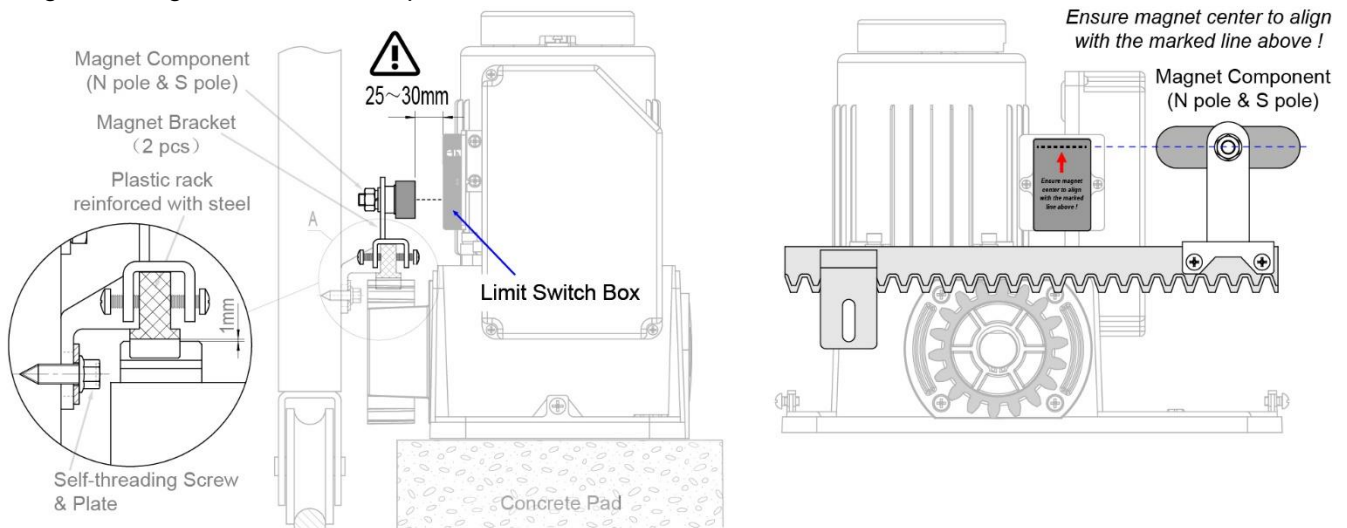



## Installation of the Magnets

Before install limit switch, make sure the gate opener is put in manual operation. (the clutch connected with gear shaft is disengaged) and the mains power supply is disconnected.

Position the S&N Magnet Components approximately on the gate and move the gate by hand to fix them in place.

### Fit magnets bracket

Push the gate fully closed by hand. Locate and install the magnet bracket so that the opener will stop at the desired close position when the close limit switch approaches it.

Push the gate fully open by hand. Locate and install the magnet bracket so that the opener will stop at the desired open position when the open limit switch approaches it.

***The magnet component with N pole outside must be installed at left side and the magnet component with S pole outside must be installed at right side from the view inside of property.***

**Ensure magnet center to align with the marked line above !**

The magnets should be **25~30mm** away from the **Limit Switch Box**. If it is too near or too far, the switches will fail to work. Adjust the position of the magnets until the positions of the opening and closing meet the requirement.

**Warning: Improper magnets installation may cause the gate crash into end barrier, which is very dangerous !**

### Important:

- \* Check that the rack teeth must engage the gear teeth throughout their full thickness. If not, adjust the position of the opener or/and place a few shims between the rack and gate.
- \* Manually slide the gate leaf to ensure the rack is proper on the gear of opener.
- \* Repeat same steps of first rack section to install the rest rack sections until proper length is reached.
- \* Cut away any excess of the rack (Note: rack length must be longer than actual travel of the gate)

## Connection of the Power Supply

**⚠ WARNING: NEVER connect the gate opener to the power outlet before all the installations have been done.**

### NOTE:

1. If batteries as are chosen as the power source, Marine or Automotive Type Battery is required. The batteries should be waterproof type, or be placed in water proof circumstance.
2. 2 PCS 12VDC batteries can be connected in series to function as 24VDC. The following diagram shows on how to connect 2 PCS batteries in series.
3. Please note that the wire connection of the power supply system is very important. Incorrect wire connection will damage the control board.

### Power Mode 1. Only use the AC electricity as the power source

The power supply cord should be at least  $3 \times 0.75\text{mm}^2$  (3C×18AWG). Connect the live wire, neutral wire and earth wire to the “L”, “N” and “PE” terminals respectively.

**NOTE: The power supply cord is not included in the package.**

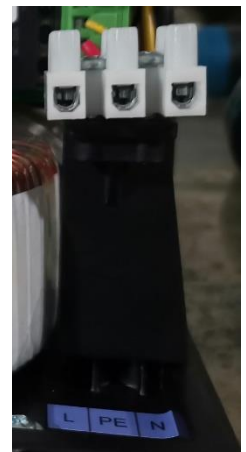

## Power Mode 2. By AC electricity and back-up batteries, only use the AC electricity to charge the batteries

If the AC electricity failure happens rarely (less than 8 hours per day), then you can use minimum 5Ah 2\*12VDC batteries as back-up power source in case of AC power failure. In this situation, you can connect the AC electricity following the “Power Mode 1” and the batteries to the BAT terminal of the control board directly as the below wiring diagram.

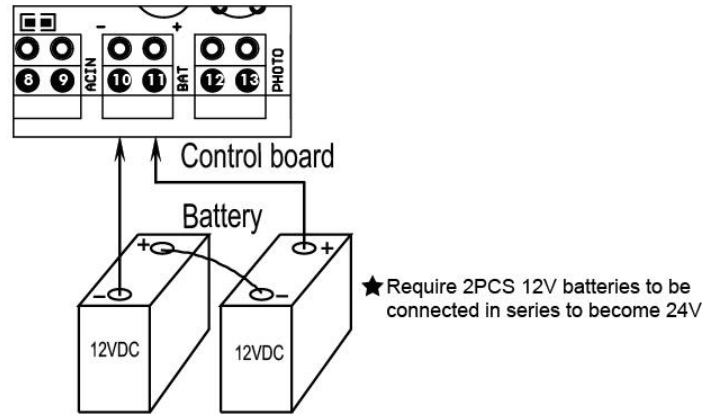

## Power Mode 3. Only use the batteries as the power source, only use the solar panel to charge the batteries

If the AC electricity is not available, then you can choose the batteries as the power source and use the solar panel to charge the batteries. The capacity of the batteries should be at least 12Ah and the power of the solar panel should be at least 30W in this situation. The gate opener can run for 10 cycles per day without connecting any other accessories except pushbutton & warning light if the local average sunshine time is more than 6 hours per day. The power of the solar panel and the capacity of the batteries should be enlarged if the local average sunshine time is less than 6 hours per day or using one of the accessories (photocell, external receiver, exit wand and keypad). Please provide us with more details of the local sunshine condition and accessories needs which we can calculate the configuration of the solar panel and the batteries. Please connect the batteries & the solar panels & solar controller refer to the following wiring diagram.

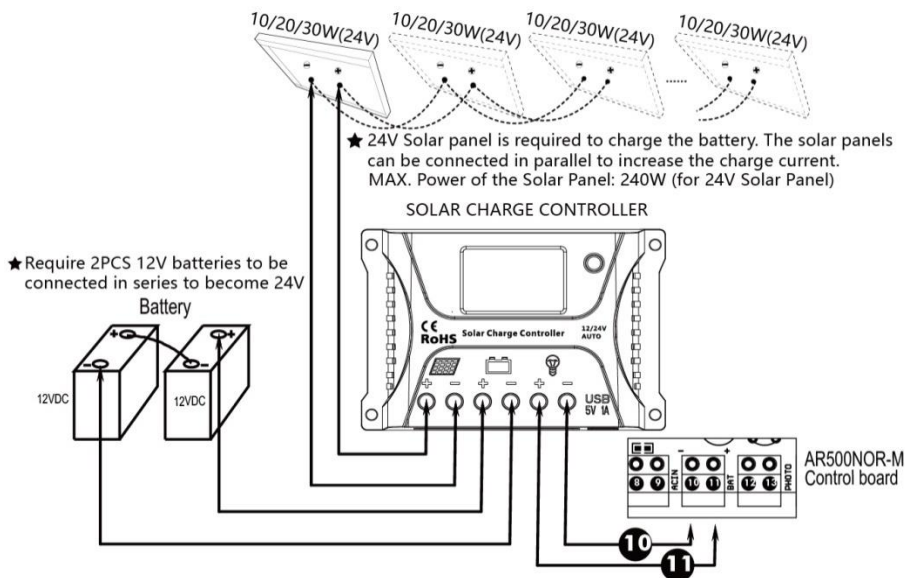

## Power Mode 4. By AC electricity and back-up batteries, use the AC electricity and the solar panel to charge the batteries at the same time

If the AC electricity failure happens frequently and lasts for a long time (maybe 4-5 days one time), then you

can charge the batteries with the AC electricity and the solar panel at the same time. The capacity of the batteries should be at least 7Ah and the power of the solar panel should be at least 20W in this situation. You can connect the AC electricity following the “**Power Mode 1**” and the batteries & the solar panels & solar controller refer to the following wiring diagram.

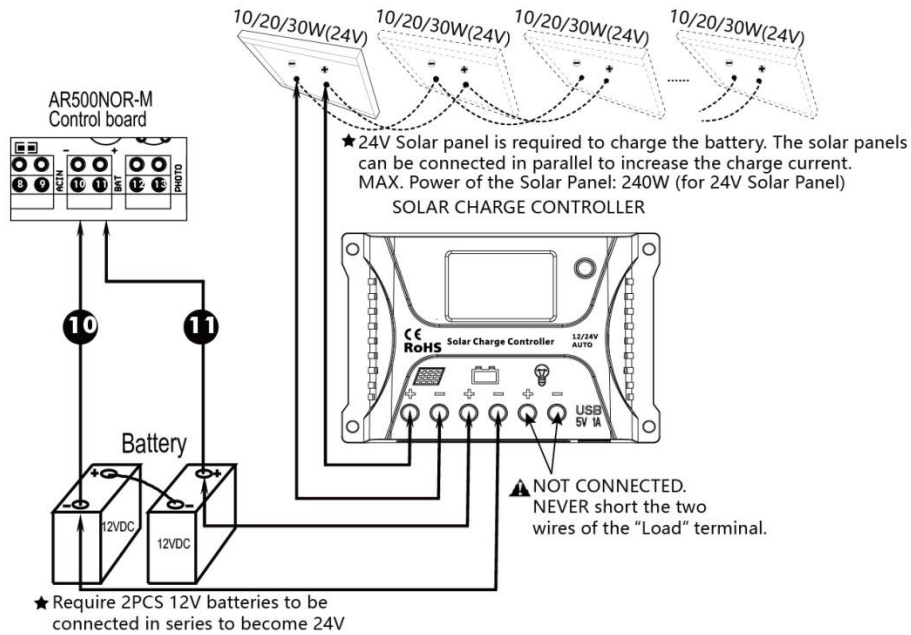

## Connecting Of the Control Board

### 1. Motor

The **YELLOW** wire of the motor should be connected into the “1” terminal.

The **RED** wire of the motor should be connected into the “2” terminal.

### 2. Limit Switches

The **YELLOW** wire of the limit switches should be connected into the “3” terminal.

The **BLACK** wire of the limit switches should be connected into the “4” terminal.

The **RED** wire of the limit switches should be connected into the “5” terminal.

### 3. Alarm Lamp (24VDC)

The **WHITE** wire of the alarm lamp should be connected into the “6” terminal.

The **RED** wire of the alarm lamp should be connected into the “7” terminal.

### 4. Photocell

Use a 2-core cable to connect the “- ~” terminal of the photocell’s emitter to the “19” terminal, the “+ ~” terminal to the “18” terminal. Also the “- ~” and “+ ~” terminals of the photocell’s receiver should be connected to the “19” and “18” terminals in parallel.

Use another 2-core cable to connect the “NC” terminal of the receiver to the “13” terminal, the “COM” terminal to the “12” terminal.

- ★ Please note that the photocell terminal must be shorted if the photocell beam system is not used. A wire jumper has been used for short the terminal in factory.
- ★ Please check if this wire jumper is missing or keep the photocell in alignment when the gate can open but fails to close.

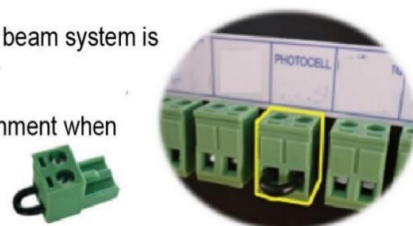
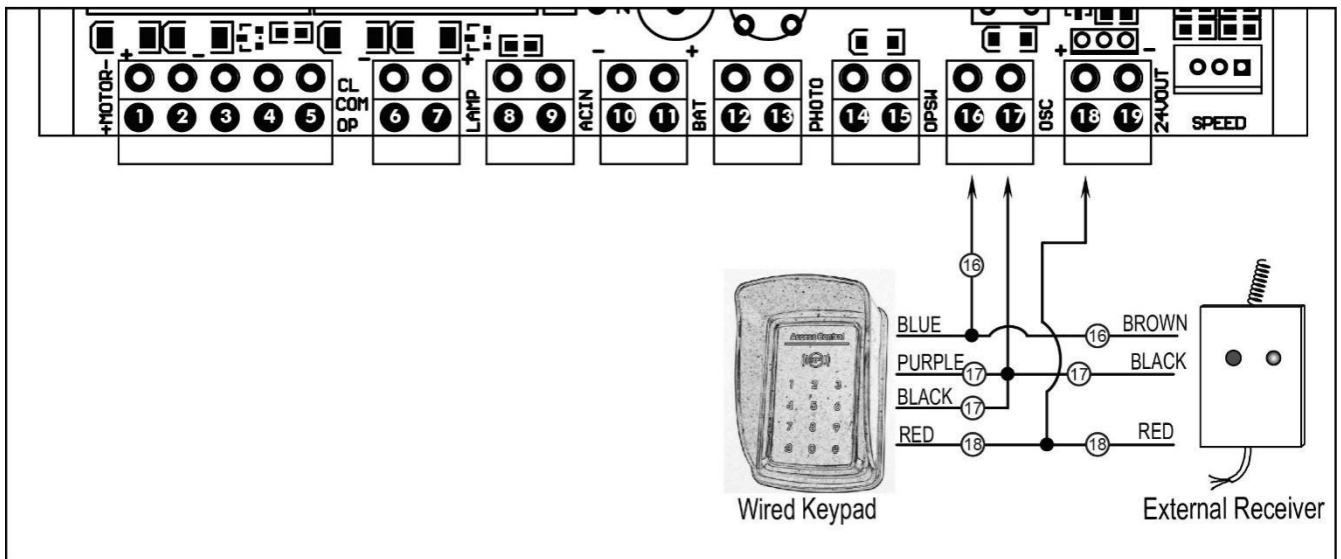
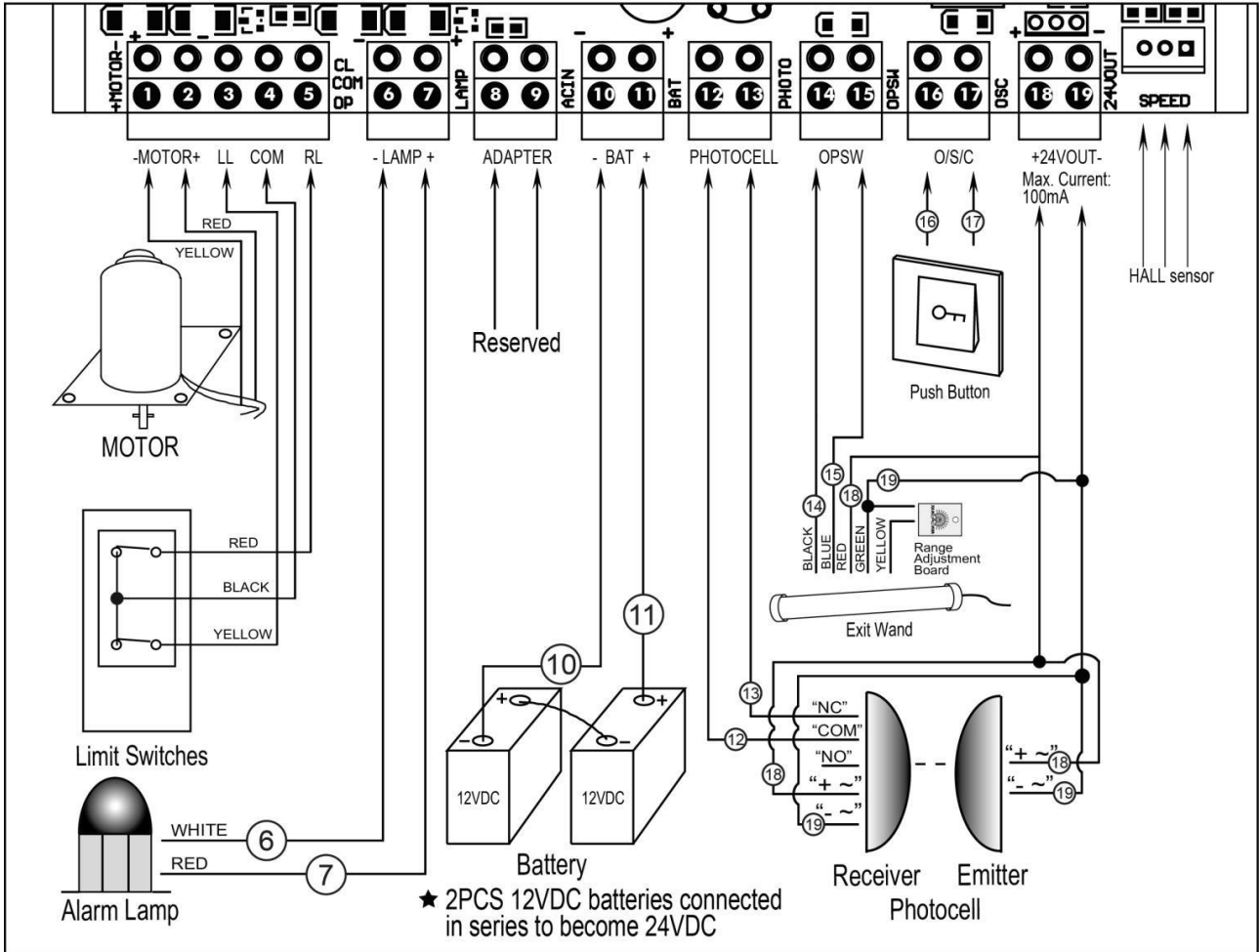
## 5. Push Button

The push button should be wired to the “16 and “17” terminals. No matter the polarity. The gate operator works alternately by pressing the button (open-stop-close-stop-open).

## 6. Exit Wand (optional)

The **BLACK** wire of the exit wand should be connected into the “14” terminal.

The **BLUE** wire of the exit wand should be connected into the “15” terminal.

The **RED** wire of the exit wand should be connected into the “18” terminal.

The **GREEN** wire of the exit wand should be connected into the “19” terminal.

The sensitivity adjustment board should be wired to the **GREEN** wire and the **YELLOW** wire of the wand. No matter the polarity.

## 7. Battery

The “**24V+**” of the battery should be wired to the **BAT+** (11) terminal, “**24V-**” should be wired to “**-BAT**” (10) terminal. If the battery has been used with solar panel, please connect the batteries and the solar panel & solar controller refers to the chapter “**Connecting of the batteries & the solar panel & solar controller**”.

## 8. External Receiver

The **BROWN** wire of the external receiver should be connected into the “16” terminal.

The **BLACK** wire of the external receiver should be connected into the “17” terminal.

The **RED** wire of the external receiver should be connected into the “18” terminal.

## 9. Wired Keypad (24VDC)

The **RED** wire of the wired keypad should be connected into the “18” terminal.

The **BLACK** wire of the wired keypad should be connected into the “17” terminal.

The **BLUE** wire of the wired keypad should be connected into the “16” terminal.

The **PURPLE** wire of the wired keypad should be connected into the “17” terminal.

**NOTE: Using of the photocell, exit wand, keypad and external receiver would cause the battery exhausted quickly. Big capacity of batteries and big power of solar panel is required if you want to use any one of them (If the batteries and solar panel is used as main power supply).**

## Setting Of the Control Board

**WARNING: Ensure the gate opener is Power Off when you make any adjustment of the gate opener. Keep away from the path of the gate during you set the gate opener system in case of the unexpected gate moving. Carefully adjust the DIP switches to avoid the risk of machine damage and injury or death. Always ask the help of professional technician /electrician if you have any question.**

### 1. DIP Switches

The DIP switches are used to set the running time of the motor in Midway mode, fine adjust the soft stop period of the motor, auto close time of the gate opener and fast change the open/close direction which is determined by the position of the gate opener installed.

**DIP Switch #1–#2: Running time of the motor in Midway Mode**

**DIP Switch #1: ON – 2 Seconds OFF – 0**

**DIP Switch #2: ON – 4 Seconds OFF – 0**

**NOTE: The midway mode function would be disabled if both DIP switches are turned off. Factory default setting is disabled. The midway mode could be activated by pressing button B of the remote control when the gate is in the full closed position.**

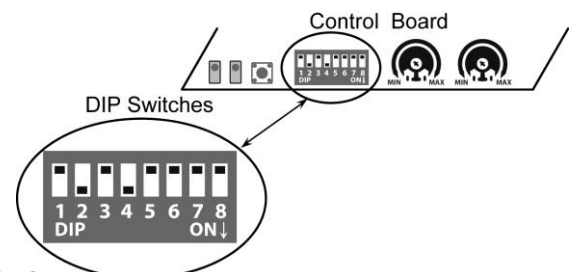

E.g.  → Running time of the opener in pedestrian mode is  $2+4=6$  seconds.

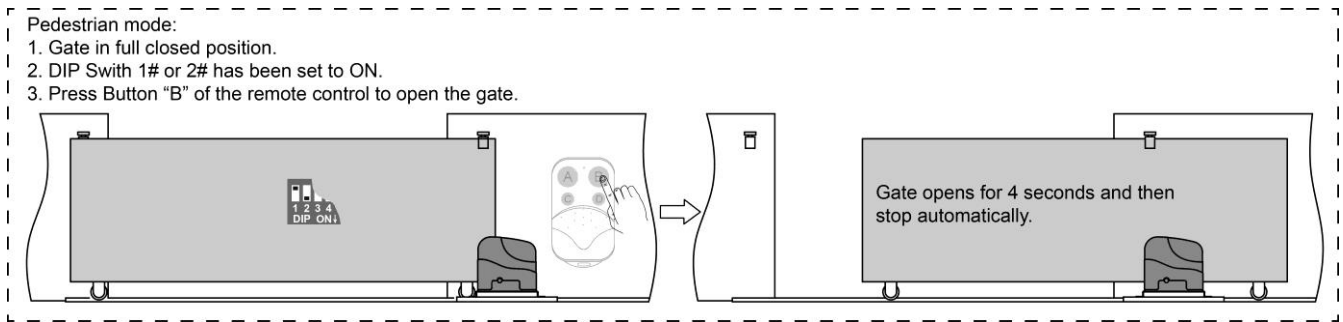

### DIP Switch #3–#5: Fine adjust the soft stop period of the motor

DIP Switch #3: ON – 1 Second OFF – 0

DIP Switch #4: ON – 2 Seconds OFF – 0

DIP Switch #5: ON – 3 Seconds OFF – 0

**NOTE:** Every time you restart the gate opener after power off, you should use the access control device (such as remote, push button and etc.) to operate the gate opener to run for a complete opening cycle and a complete closing cycle to get the full opening time and the full closing time. You would achieve the soft stop in your next opening/closing cycle. Factory default soft stop time is 3 Second. You can turn the DIP switches on/off to fine adjust the soft stop time to meet your actual needs.

E.g.  → The soft stop period of the motor is  $1+2=3$  seconds.

### DIP Switch #6–#7: Auto close time of the gate opener

DIP Switch #6: ON – 30 Seconds OFF – 0

DIP Switch #7: ON – 60 Seconds OFF – 0

**NOTE:** The auto close function would be disabled if both DIP switches are turned to off (factory default setting).

E.g.  → Auto close time of the gate opener is  $30+60=90$  seconds.

### DIP Switch #8: Left/Right open

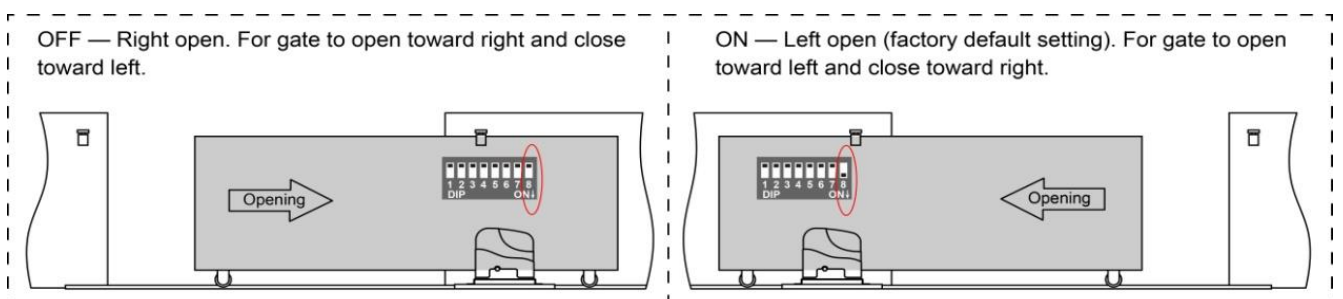

## 2. Potentiometers

**Potentiometer A** is used to adjust the close stall force the gate operator. Turn clockwise to increase the stall force, and turn it counter-clockwise to decrease the stall force.

**Potentiometer B** is used to adjust the open stall force the gate operator. Turn clockwise to increase the stall force, and turn it counter-clockwise to decrease the stall force.

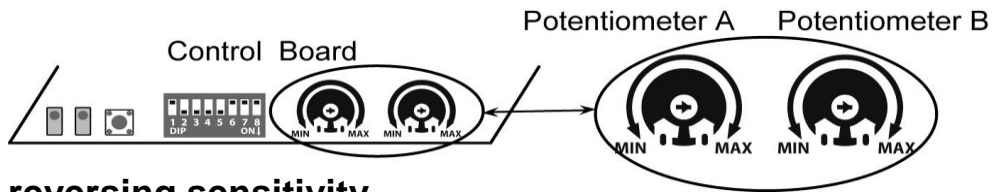

## Test the reversing sensitivity

For the sake of safety, it is very important to test the reversing sensitivity as soon as the control board set is finished.

The reversing sensitivity adjustment is inverse correlation with stall force adjustment in potentiometer A and B. In other word, the stall force level is higher; the reversing sensitivity level is lower.

Put an immobile object along the gate path, and then operate the gate to strike it during the close cycles. The gate must reverse as soon as object is struck with it. If the gate doesn't reverse, please increase the reversing sensitivity by turning the potentiometer in counter-clockwise direction. (Turning the stall force potentiometer toward to MIN position to increase the reversing sensitivity)

**Note 1: If the sensitivity setting is too higher, the gate will stop or reverses very easy by itself while there is little obstruction or resistance such as strong wind or heavy snow sometimes.**

**Note 2: Always check the gate reversing function every each time of control board set or restart after power off.**

## How to learn or erase the remote

### Learn the remote

Press and release the learn button, the **REM LED** light will be on, then press the key in the remote twice in 2 seconds, the **REM LED** light will flash for 4 seconds. Now the remote has been learnt successfully.

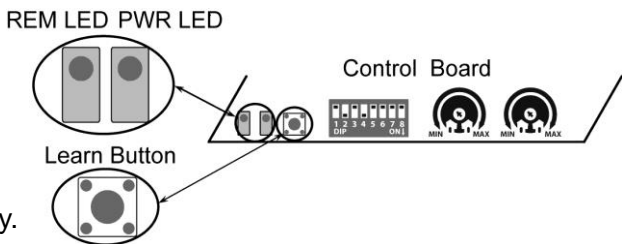

### Erase all the remote codes

Press and hold the learn button until the **REM LED** light is off. Now all remote codes have been erased.

## How to use the remote to control the opener

**Key A** is used to operate the opener to work alternately (open-stop-close-stop-open).

When the Pedestrian Mode function is enabled, **Key B** is used to achieve the Pedestrian Mode function (open the gate for the pre-setting time). When the Pedestrian Mode function is disabled, the opener works alternately (open-stop-close-stop-open) by pressing **Key B**.

The **Key C** and **Key D** are reserved for garage door opener, swing gate opener in our brand. While if you want to use **Key C** and or **Key D** to control a second sliding gate opener, an external receiver (optional) is necessary.

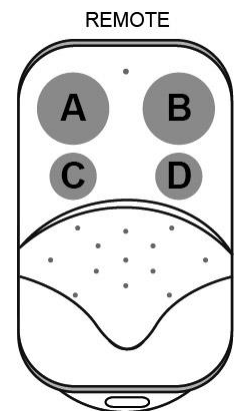

## Troubleshooting

Have a multi-meter to check voltage and continuity. Use caution when checking high voltage terminals.

Symptom	Possible Solution(s)
The opener does not run. Power LED is OFF.	<ol style="list-style-type: none"> <li>1. Make sure that the power cord is properly plugged into the mains outlet.</li> <li>2. Check if the output voltage of the transformer is 24VAC. If the voltage measures 0, the transformer may be overheated or damaged. Turn power off and allow board to cool for several minutes then reset. Replace the transformer if the symptom still exists.</li> <li>3. Check the fuse in the control board. Replace the fuse if it was burnt out.</li> <li>4. Check the status of the over-discharged LED on the solar controller, the voltage of the batteries is too low to power the gate opener if the LED is ON. Please wait the batteries are charged to full.</li> <li>5. The solar controller could be faulty if the over-discharged LED is ON when the voltage of the batteries is normal (&gt;24VDC).</li> <li>6. Check the control board. Replace the control board if necessary.</li> </ol>
The opener does not run. Power LED is ON.	<ol style="list-style-type: none"> <li>1. Check to be sure the beam is not blocked if a photocell is used as a secondary entrapment prevention device. If a photocell is not used, photocell terminal of the control board should be shorted by a jumper wire.</li> <li>2. Check the motor. Release the clutch then disconnect the wires of the motor from terminal 1 and 2. Connect the wires to 24V battery directly, the motor should run, and then exchange the wires, the motor should run in the opposite direction. If the motor runs in both directions, please check the other parts listed below.</li> <li>3. Check the limit switch. Use a jumper wire to short terminal 4 with terminal 3 and 5, and then use a keying device to operate the opener, replace the limit switch if the motor could run in both directions.</li> <li>4. Check the control board. Replace the control board if necessary.</li> </ol>
Remote control does not work.	<ol style="list-style-type: none"> <li>1. The indicator light of remote control is not on. Check the battery in your remote control. Replace the battery if necessary.</li> <li>2. The distance you use the remote is too far away from the opener. Try it again closer.</li> <li>3. Remote control is not suitable for receiver. After making sure the codes are correct, erase remote controls and then re-program the codes in the device.</li> <li>4. Check the control board. Replace the control board if necessary.</li> </ol>
The gate starts but it is immediately stop or reverse	<ol style="list-style-type: none"> <li>1. Check the HALL sensor board in the side of the gear box has been connected to the control board tightly.</li> <li>2. Check that the clutch is adjusted properly and is not slipping.</li> <li>3. The opening force or closing force is adjusted too small. Turn the Potentiometer A&amp;B to increase the force.</li> <li>4. Disconnect the gate from the gate opener and check that the gate slides freely without any binding.</li> <li>5. Check the control board. Replace the control board if necessary.</li> </ol>



<p>The gate opens, but stops and will not return.</p>	<ol style="list-style-type: none"> <li>1. Please note the two limit magnets are different: one is N pole and another is S pole. Please try to exchange the two magnets.</li> <li>2. Please try to exchange the limit switch wires CL (close) and OP (open).</li> <li>3. Maybe the magnet was installed in the wrong position so it inducts both switches. Adjust the magnets to the correct position refer to the manual.</li> <li>4. Check the control board. Replace the control board if necessary.</li> </ol>
<p>The gate can open, but fails to close.</p>	<ol style="list-style-type: none"> <li>1. Photocell is obstructed. Remove obstruction.</li> <li>2. The limit switch is failed. Use a jumper wire to short terminal 4 with terminal 3 and 5, and then use a keying device to operate the opener, replace the limit switch if the motor could run in both directions.</li> <li>3. Check the control board. Replace the control board if necessary.</li> </ol>

## Maintenance

Every six months check the following items for proper operation of the unit.

- \* Lubricate shafts and gears.
- \* Keep opener clean at all times.
- \* Check and tighten anchors bolts.
- \* Check for loose or corroded wire
- \* Ensure the opener is well earthed, and correctly terminated.
- \* Always check the Stop/Reverse in case of obstruction function when performing any maintenance. If this function can't be made operable, remove this opener from service until the cause of the malfunction is identified and corrected.



According to Waste of Electrical and Electronic Equipment (WEEE) directive, WEEE should be separately collected and treated. If at any time in future you need to dispose of this product please do NOT dispose of this product with household waste. Please send this product to WEEE collecting points where available.

[www.Aleko.com](http://www.Aleko.com)

8307 S 192nd St Kent WA 98032 USA

Phone : 833-926-2323

[hello@alekoproducts.com](mailto:hello@alekoproducts.com)

©2023-2026 ALEKO All Rights Reserved