

**ALEKO®**

# **Sliding Gate Opener User's Manual**

**Model:**

**AR1550 / AR2450**



- ★ Please read and follow all warnings, precautions and instructions before installation and use
- ★ Periodic checks of the opener are required to ensure safe operation.
- ★ For residential use only
- ★ Save this manual

[www.AlekoProducts.com](http://www.AlekoProducts.com)

VER 16b

# Table of Contents

General Safety .....	2
Preparation for Installation .....	3
Parts List .....	4
Optional Accessories Part List .....	5
Technical Specifications & Feature .....	5
Installation Overview .....	6
Installation of the Opener .....	6
Manual Operation .....	7
Fit The Rack .....	7
Installation of the magnets.....	8
Connecting of power supply .....	9
Connecting of the Control Board .....	9
Setting of the Control Board .....	11
Test the reversing sensitivity .....	13
How to learn or erase the remote .....	13
How to use the remote to control the operator .....	13
Trouble Shooting .....	14
Maintenance .....	14

Thank you for purchasing our sliding gate opener. We are sure that the products will be greatly satisfying as soon as you start to use it.

The product is supplied with a user's manual which encloses installation and safety precautions. These should be read carefully before installation and operation as they provide important information about safety, installation, operation and maintenance. This product complies with the recognized technical standards and safety regulations.

## General Safety



**WARNING!** An incorrect installation or improper use of the product can cause damage to persons, animals or properties.

- Scrap packing materials (plastic, cardboard, polystyrene etc.) according to the provisions set out by current standards. Keep nylon or polystyrene bags out of children's reach.
- This product was exclusively designed and manufactured for the use specified in the present documentation. Any other use not specified in this documentation could damage the product and be dangerous.
- The factory declines all responsibility for any consequences resulting from improper use of the product, or use which is different from that expected and specified in the present documentation.
- Do not install the product in explosive atmosphere.
- The factory declines all responsibility for any consequences resulting from failure to observe Good Technical Practice when constructing closing structures (door, gates etc.), as well as from any deformation which might occur during use.
- Disconnect the electrical power supply before carrying out any work on the installation. Also disconnect any buffer batteries, if fitted.
- Fit an omnipolar or magnetothermal switch on the mains power supply, having a contact opening distance equal to or greater than 3,5 mm.
- Make sure a residual current circuit breaker with a 30mA threshold is fitted before the power supply mains.
- Check that earthing is carried out correctly: connect all metal parts for closure (doors, gates etc.) and all system components provided with an earth terminal.
- Fit all the safety devices (photocells, electric edges etc.) which are needed to protect the area from any danger caused by squashing, conveying and shearing.
- The factory declines all responsibility with respect to the automation safety and correct operation when other supplier's components are used.
- Only use original parts for any maintenance or repair operation.
- Do not modify the automation components, unless explicitly authorized by the factory.
- Instruct the product user about the control systems provided and the manual opening operation in case of emergency.
- Do not allow persons or children to remain in the automation operation area.
- Keep radio control or other control devices out of children's reach, in order to avoid unintentional automation activation.
- The user must avoid any attempt to carry out work or repair on the automation system, and always request the assistance of qualified personnel.
- Anything which is not expressly provided for in the present instructions is not allowed.
- Before installing the gate opener, check that all moving part as well as the sliding gate is in good mechanical condition, correctly balanced and opens and closes properly.
- Save these instructions for future use.

## Preparation for Installation

Before proceeding to your opener installation, check if your gate structure is in accordance with the current standards, especially as follows:

The gate sliding track is linear and horizontal. The wheels are suitable for use. The gate should be mounted and moved freely. Check that the structure is sufficiently strong and rigid, and that its dimensions and weights conform to those listed in the specifications table of this document. Make sure that the gate is plumb and level. The fence posts must be mounted in concrete. The gate does not bind or drag on the ground.

- The gate manual operation can be carried out smoothly along its entire run, and there is no excessive side slipping.
- The opening and closing gate stops are positioned.



**WARNING:** Remember that control devices are intended to facilitate gate operation, but can not solve problems due to any defects or deficiency resulting from failure to carry out correct installation or maintenance. Take the product out of its packing and inspect it for damage. Should it be damaged, contact your dealer. Remember to dispose of its components (cardboard, polystyrene, nylon, etc.) according to the current prescriptions.

Refer to the following Figures for gate installation.

Using the post or wall as a stop, either directly or indirectly, is not recommended so as to protect the post or wall against damaging shock from the sliding gate.

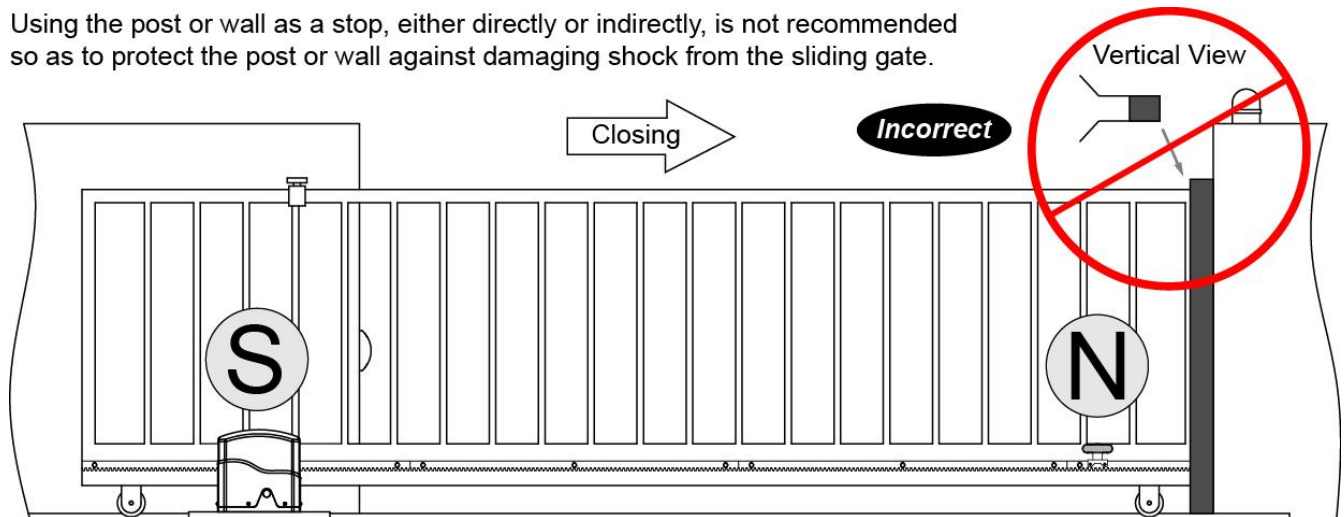



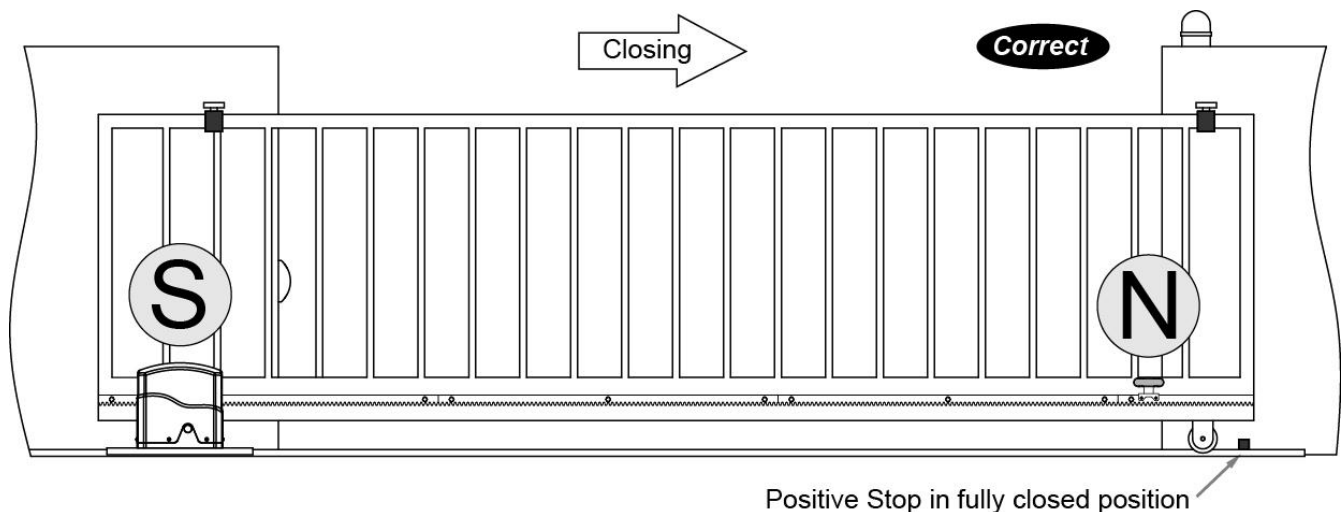

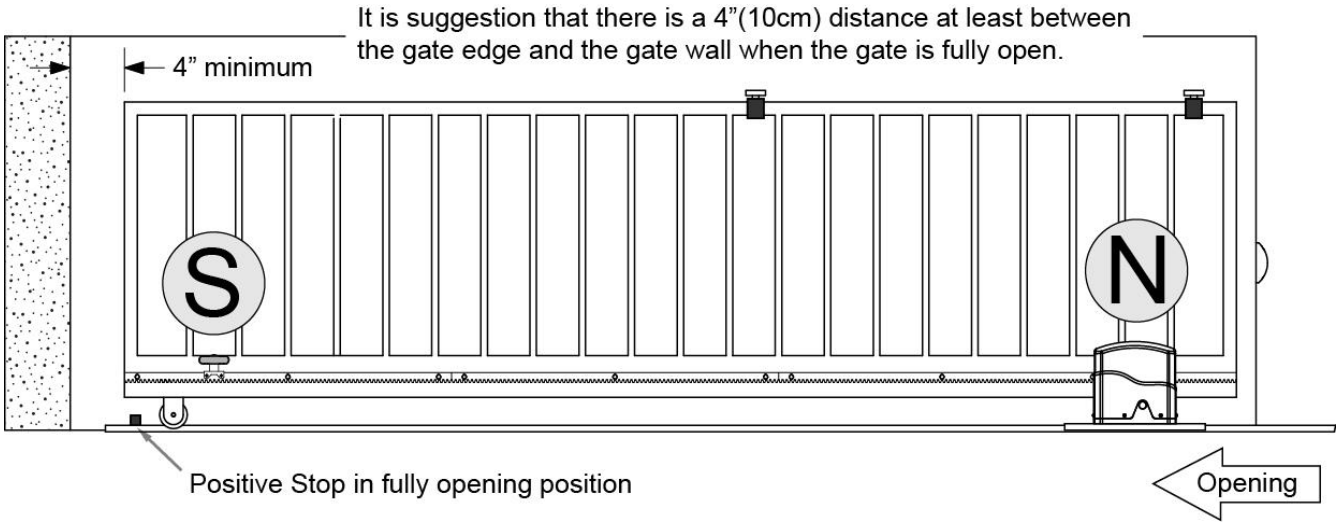









In sake of safety, a positive stop must be mounted on the two end of ground track.











## Parts List

 <p>Gate Opener (1 pc)</p>		 <p>Φ10 Washer (4 pcs)</p>	 <p>Anchor Bolt (4 pcs)</p>
		 <p>Φ10 Lock Washer (4 pcs)</p>	 <p>M10 Nut (4 pcs)</p>
 <p>Remote Control (2 pcs)</p>	 <p>Release Key (1 pc)</p>	 <p>Magnet Bracket (2 pcs)</p>	 <p>Pan Head Screw M5×12 (8 pcs)</p>
 <p>Galvanized Steel Rack 1005mm×N(pcs) (Optional) <b>4pcs</b></p>		 <p>Magnet Assembly (N pole) (1 pc)</p>	 <p>Magnet Assembly (S pole) (1 pc)</p>
 <p>Plastic Rack Reinforced with Steel 1005mm×N(pcs) (Optional) <b>4pcs</b> Light Duty</p>		 <p>Plastic Rack Reinforced with Steel 1005mm×N(pcs) (Optional) <b>4pcs</b> Heavy Duty</p>	

## Optional Accessories Parts List

Optional			
 Alarm Lamp (1 pc) (LM141)	 Photocell Beam System (1 set) (LM102)	 Wall push button (1 pc) (LM147)	 Wireless push button (1 pc) (LM173)
 External Receiver (1 pc) (LM138)	 Wireless Keypad (1 pc) (LM172)	 Mounting post for keypad (1 pc) (LM107)	

## Technical Specifications & Features

Specifications		
	AR1550	AR2450
Power supply:	120V/60Hz or 230V/50Hz	
Motor voltage:	120VAC or 230VAC	
Frequency	433.92MHz	
Absorbed power:	300W	500W
Gate moving speed:	15 cm/second	
Max gate weight:	600KGS/1500LBS	1000KGS/2400LBS
Max torque:	12Nm	24Nm
Environmental conditions:	From -15°C to +40°C	
Protection class:	IP44	
Dimensions:	25.2x22x25 CM	

### Features:

- Midway mode.
- Quick selection for the gate open/close direction
- Reliable rolling code technology for remote control
- Emergency release key in case of power failure

- Stop in case of obstruction during gate opening
- Reverse in case of obstruction during gate closing
- Built in adjustable auto-close
- Built in motor running limitation: max. 90 sec
- Reliable electromagnetism limit for easy adjustment
- Can be equipped with a wide range accessories

## Installation Overview

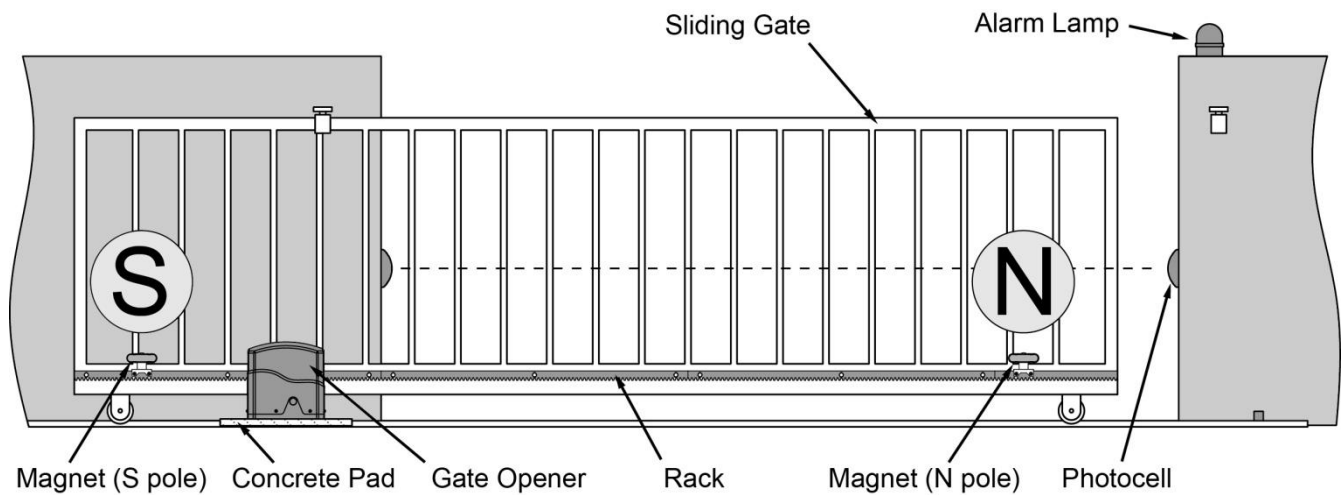

## Installation of the Opener

### Caution:

\*Be sure that the opener is installed in a level and paralleled position and is properly secured. Improper installation could result in property damage, severe injury, and/or death.

\* Before starting installation, ensure that there is no point of friction during the entire movement of the gate and there is no danger of derailment.

\* Ensure that the safety side panels are present.

**Necessary Tools:** The following tools may be necessary to install the Gate opener. You will need screwdrivers, an electric drill, wire cutters and a wire stripper, a socket set, and possibly access to a welder.

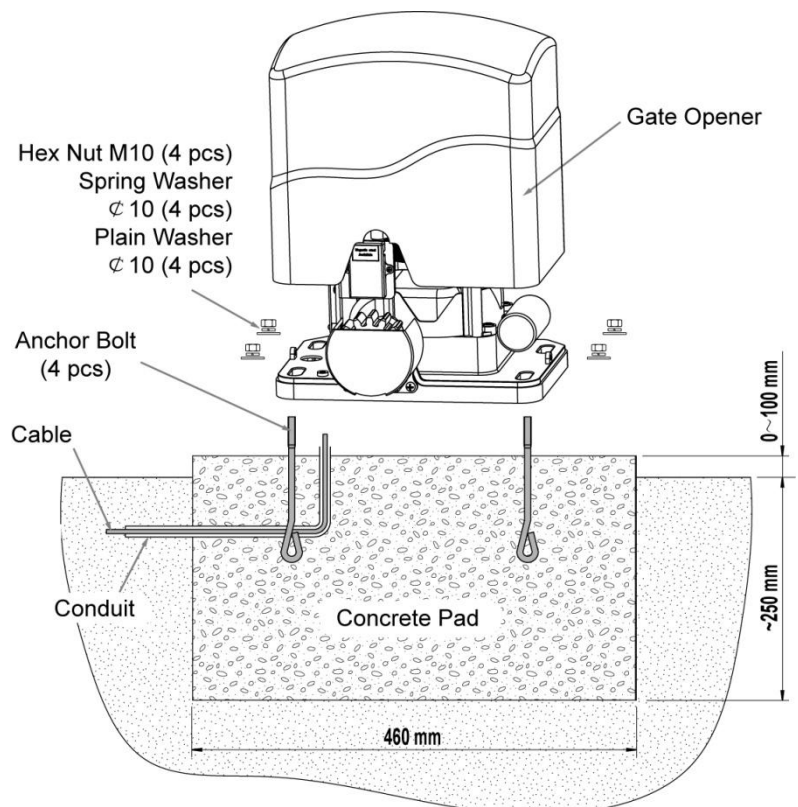



When install the opener, you should build a concrete pad to support the base plate of opener in order to maintain proper stability.

### The installation proceeds are as follows:

1. Dig a hole for a concrete pad which should be approximately 46 x 42 x 35cm (18" x 16.5" x 14" ). It may protrude 10 cm (4") above ground and 25 cm (10") in depth underground. Increase the pad height if necessary to protect the system from flooding, heavy snow etc.
2. Prepare one or more conduits for the electrical cables before pour concrete. Remember that cable conduits have to pass through the hole in opener base.
3. Pour concrete and before it starts to harden, check that it is parallel to the gate leaf and perfectly level.
4. The four anchor bolts must be set into the concrete when it is poured, make sure the position of anchor bolts was placed according to the position of mounting holes on the opener base before concrete become harden.
5. Mount the opener to the concrete Pad. It's only temporary installation. Further adjustment will be required when install the rack.

## Manual Operation

You can open the gate by manual when power failure. And the opener should be put in the manual (emergency release) position before fitting the rack, installing the opener and limit switch. The process is as follows:

- 1) Take off the rubber stopple.
- 2) Insert the Release Key (provided) and turn it in counter-clockwise 180° to disengage the clutch between the gear shaft and power output. Now the opener is in the manual operation.

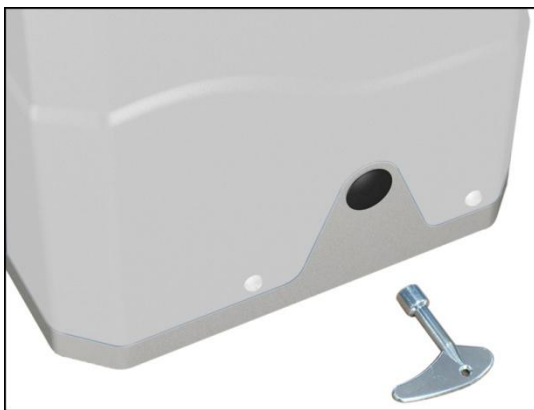

## Fit the Rack

There are two kinds of rack available as per your options, which are steel reinforced plastic rack and galvanized steel rack. The galvanized steel rack is usually used for the heavy duty gate.

### A. Fit the plastic rack reinforced with steel

1. Start with gate in closed position
2. There are four sections of plastic rack which is one meter length. (you can order extra rack from dealer if necessary)
2. Put one end of rack section on the gear of opener as a temporary support. Make rack level and mark the rack's mounting holes (**four holes for light duty or six holes for heavy duty**) on the gate.
3. Fit the rack by self-threading screws. This kind of plastic rack is quieter and allows height adjustments to



be made even after it has been fixed. Please keep 1.0mm space between the rack and the gear to avoid the weight of the gate effect on the opener.

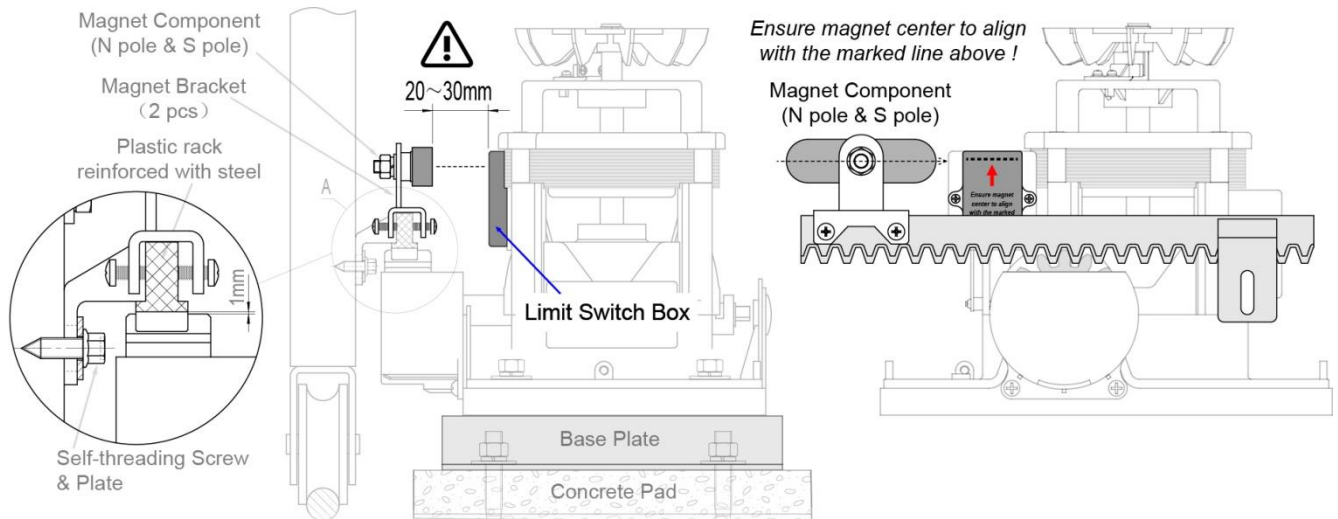

## B. Fit the galvanized steel rack

1. Start with gate in closed position
2. There are four sections of steel rack which is one meter length. (you can order extra rack from dealer if necessary)
2. Put one end of rack section on the gear of opener as a temporary support. Make rack level and mark the rack's mounting holes (**three holes**) on the gate.
3. Weld the rack nut on the gate as mark and connect the rack to the gate using the bolt provided. Before weld, please keep 1.0mm space between the rack and the gear to avoid the weight of the gate leaf effect on the opener.

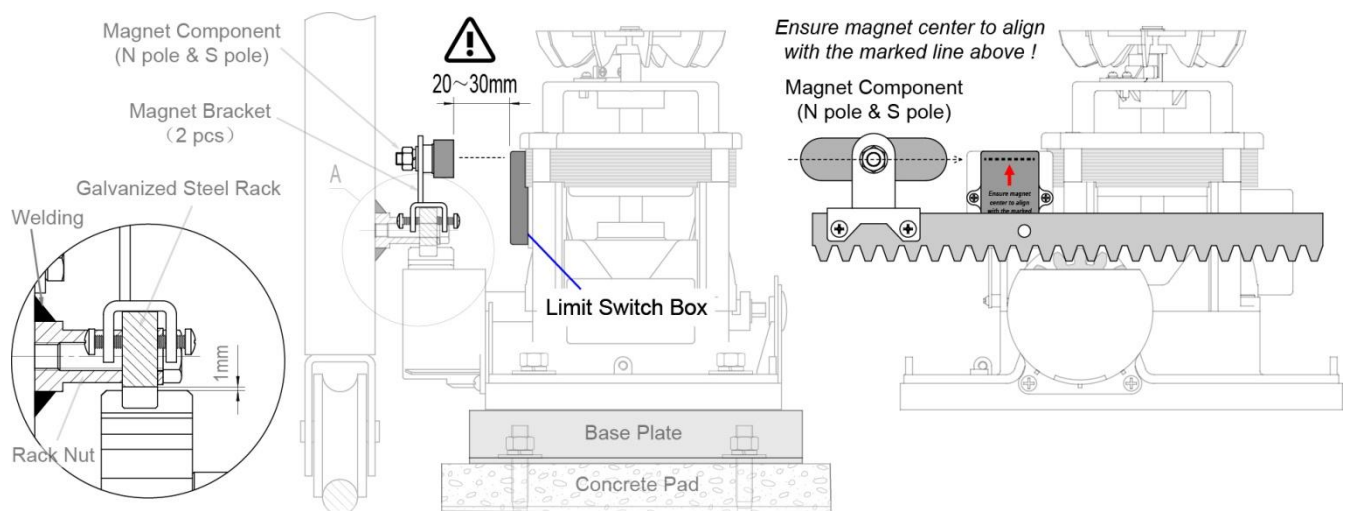

## Installation of the Magnets

Before install limit switch, make sure the gate opener is put in manual operation. (the clutch connected with gear shaft is disengaged) and the mains power supply is disconnected.

Position the S&N Magnet Components approximately on the gate and move the gate by hand to fix them in place.

### Fit magnets bracket

Push the gate fully closed by hand. Locate and install the magnet bracket so that the opener will stop at the

desired close position when the close limit switch approaches it.

Push the gate fully open by hand. Locate and install the magnet bracket so that the opener will stop at the desired open position when the open limit switch approaches it.

***The magnet component with S pole outside must be installed at left side and the magnet component with N pole outside must be installed at right side from the view inside of property.***

**Ensure magnet center to align with the marked line above !**

The magnets should be **20~30mm** away from the **Limit Switch Box**. If it is too near or too far, the switches will fail to work. Adjust the position of the magnets until the positions of the opening and closing meet the requirement.

**Warning: Improper magnets installation may cause the gate crash into end barrier, which is very dangerous !**

### **Important:**

\* Check that the rack teeth must engage the gear teeth throughout their full thickness. If not, adjust the position of the opener or/and place a few shims between the rack and gate.

4. Manually slide the gate leaf to ensure the rack is proper on the gear of opener.

5. Repeat same steps of first rack section to install the rest rack sections until proper length is reached.

6. Cut away any excess of the rack (Note: rack length must be longer than actual travel of the gate)

7. Thoroughly fasten the four nuts as well as spring washers onto expansion bolts tightly, enabling the opener is firmly secured on the concrete pad during the whole gate travel.

## **Connecting Of Power Supply**

The power supply cord should be at least 3×0.75mm<sup>2</sup>. Connect the live wire and neutral wire to the “L”(2) and “N”(1) terminal respectively; and connect the earth wire to “PE”.

**NOTE: The power supply cord is not included in factory.**



## **Connecting Of the Control Board**

### **1. Motor**

The **BLACK** wire of the motor should be connected into the “3” terminal.

The **YELLOW** wire of the motor should be connected into the “4” terminal.

The **RED** wire of the motor should be connected into the “5” terminal.

### **2. Limit Switches**

The **YELLOW** wire of the limit switches should be connected into the “8” terminal.

The **BLACK** wire of the limit switches should be connected into the “9” terminal.

The **RED** wire of the limit switches should be connected into the “10” terminal.

### **3. Alarm Lamp (Optional)**

One wire of the alarm lamp should be connected into the “6” terminal, another should be connected into the “7” terminal.

### **4. Start Capacitor**

The two wires of the start capacitor should be connected into the “4” terminal and “5” terminal.

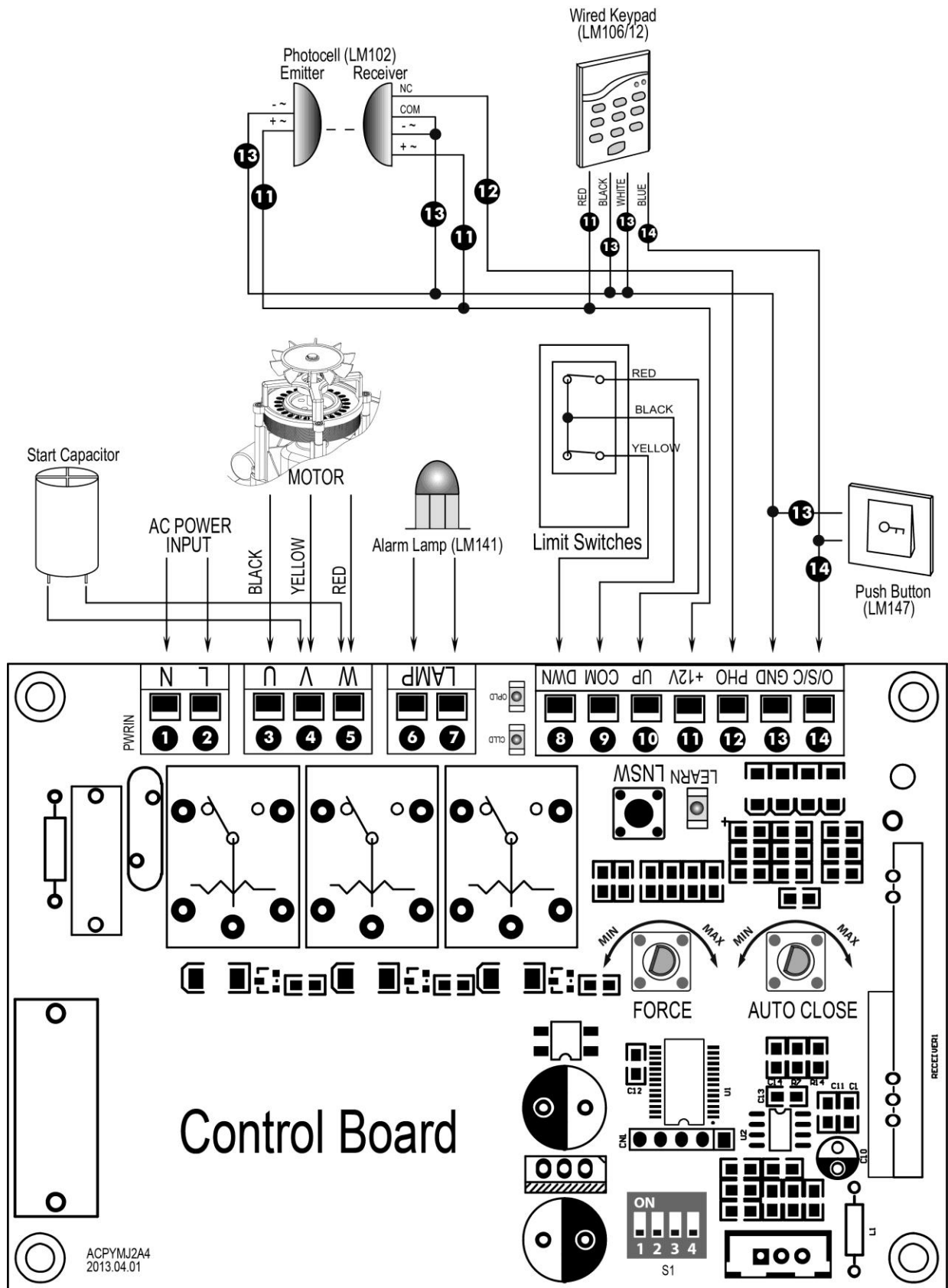

### 5. Photocell (Optional)

Use a 2-core cable to connect the “+ ~” terminal of the photocell’s emitter to the “11” terminal, the “- ~” terminal to the “13” terminal. Also the “+ ~” and “- ~” terminals of the photocell’s receiver should be connected to the “11” and “13” terminals in parallel.

Use another 2-core cable to connect the “COM” terminal of the receiver to the “13” terminal, the “NC” terminal to the “12” terminal.

## TIPS

The terminal 12 and 13 on control board should be shorted if the photocell beam system (optional) does not use. A wire jumper has been used for short to terminal 12 and 13 in factory.

Please check if this wire jumper is missing or keep the photocell in alignment when the gate can open but fails to close.



## 5. Wired Keypad (12VDC)

The **RED** wire of the wired keypad should be connected into the “11” terminal.

The **BLACK** wire of the wired keypad should be connected into the “13” terminal.

The **WHITE** wire of the wired keypad should be connected into the “13” terminal.

The **BLUE** wire of the wired keypad should be connected into the “14” terminal.

## 6. Push Button (Optional)

The push button should be wired to the “13” and “14” terminals. The gate operator works alternately by pushing the button (open-stop-close-stop-open).

## Setting Of the Control Board

**WARNING: Ensure the gate opener is Power Off when you make any adjustment of the gate opener. Keep away from the gate during you set the gate opener system in case of the unexpected gate moving. Carefully adjust the DIP switches to avoid the risk of machine damage and injury or death. Always ask the help of professional technician /electrician if you have any question.**

### 1. DIP Switches

The DIP switches are used to set the running time of the motor in pedestrian mode, enable/disable auto close function of the gate operator and fast change the open/close direction which is determined by the position of the gate operator installed.

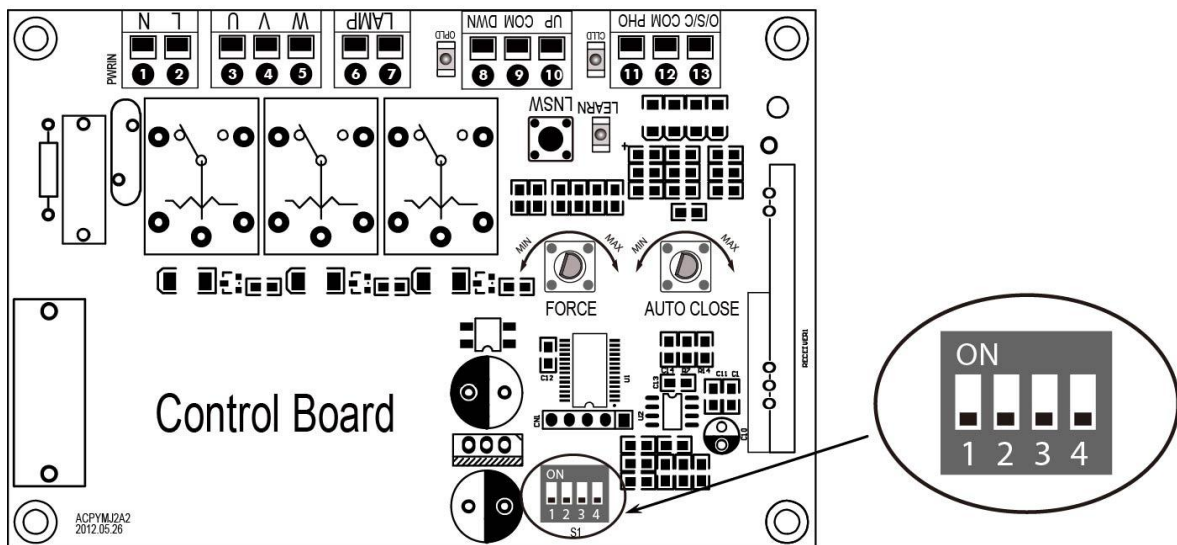

**DIP Switch #1–#2: Running time of the motor in Midway Mode**

**DIP Switch #1: ON – 2 Seconds OFF – 0**

**DIP Switch #2: ON – 4 Seconds OFF – 0**

**NOTE: The midway mode function would be disabled if both DIP switches are turned off. Factory**

default setting is disabled. The midway mode could be activated by pressing button B of the remote control when the gate is in the full closed position.

E.g.  → Running time of the operator in pedestrian mode is 2 seconds.

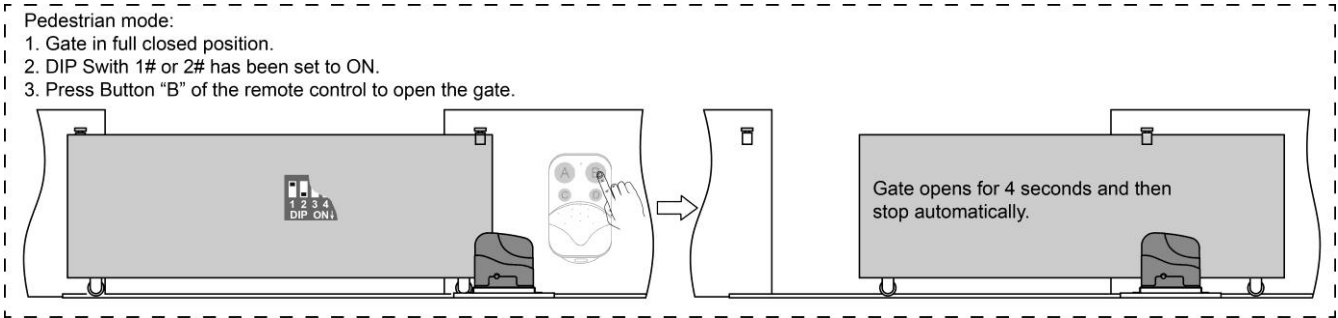

**DIP Switch #3: Auto close function enabled/disabled**

**DIP Switch #3: ON** – auto close function enabled  
**OFF** –auto close function disabled

E.g.  → Auto close function of the opener has been enabled. Factory default setting is disabled.

**DIP Switch #4: Left/Right open**

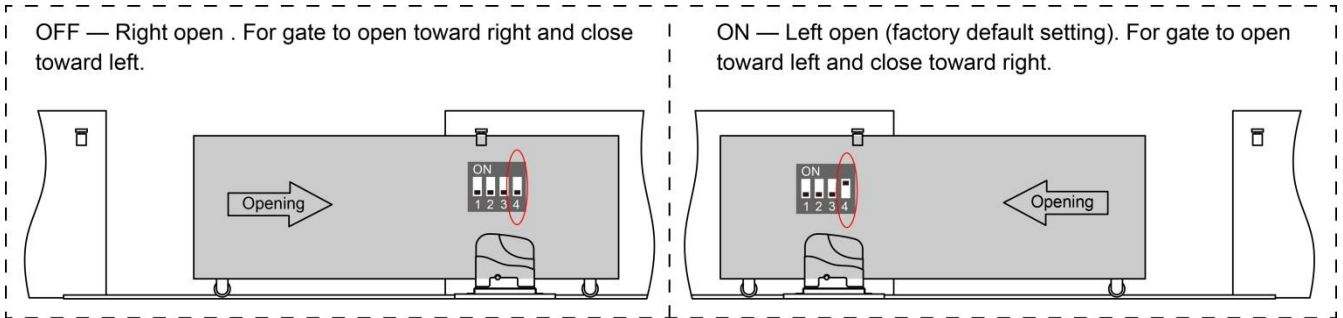

**2. Potentiometers**

Potentiometer A and B are used to adjust the stall force and auto close time of the gate operator separately. Turn **potentiometer A** clockwise to increase the stall force, and turn it counter-clockwise to decrease the stall force.

Turn **potentiometer B** clockwise to increase the auto close time, and turn it counter-clockwise to decrease the auto close time, the auto close time could be adjusted steplessly from 1 to 99 seconds.

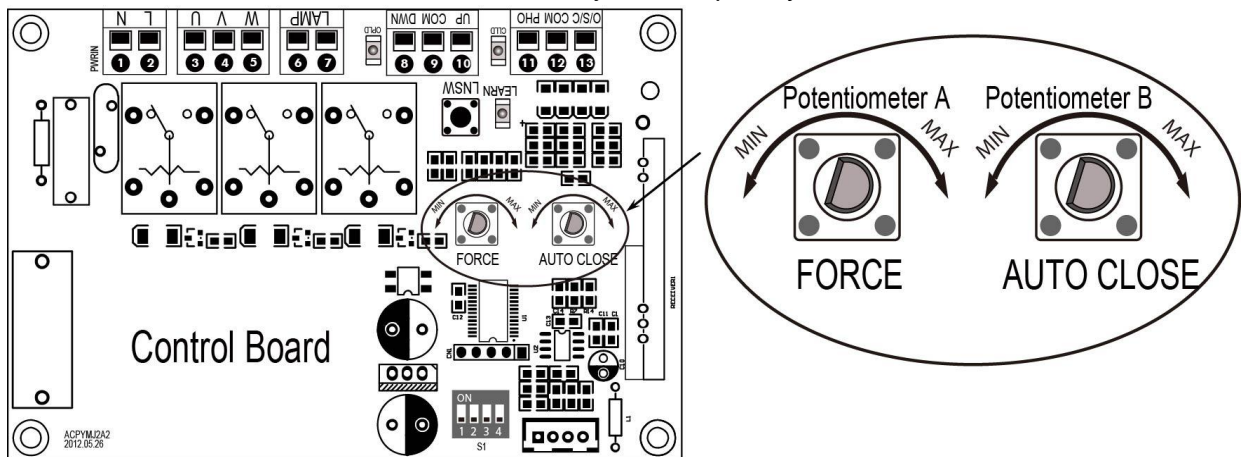



## Test the reversing sensitivity

For the sake of safety, it is very important to test the reversing sensitivity as soon as the control board set is finished.

The reversing sensitivity adjustment is inverse correlation with stall force adjustment in potentiometer A and B. In other word, the stall force level is higher; the reversing sensitivity level is lower.

Put an immobile object along the gate path, and then operate the gate to strike it during the **close cycles**. The gate must reverse as soon as object is struck with it. If the gate doesn't reverse, please increase the reversing sensitivity by turning the potentiometer A in counter-clockwise direction. (Turning the stall force potentiometer toward to MIN position to increase the reversing sensitivity)

**Note 1: If the sensitivity setting is too higher, the gate will stop or reverses very easy by itself while there is little obstruction or resistance such as strong wind or heavy snow sometimes.**

**Note 2: Always check the gate reversing function every each time of control board set or restart after power off.**

## How to learn or erase the remote

### Learn the remote

Press and release the learn button, the **LEARN LED** light will be on, then press the key A or B on the remote twice in 2 seconds, the **LEARN LED** light will flash for 4 seconds. Now the remote has been learnt successfully. This control board can learn up to six remotes , if you want to learn more, we recommend that you buy the external receiver (LM138) .

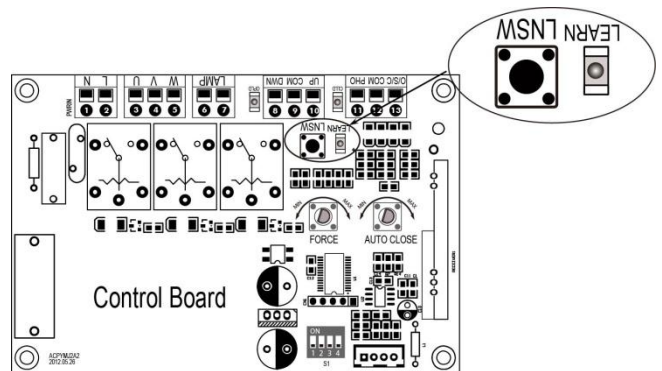

### Erase all the remote codes

Press and hold the learn button until the **LEARN** light is off. Now all remote codes have been erased.

## How to use the remote to control the operator

**Key A** is used to operate the opener to work alternately (open-stop-close-stop-open). When the Pedestrian Mode function is enabled, **Key B** is used to achieve the Pedestrian Mode function (open the gate for the pre-setting time). When the Pedestrian Mode function is disabled, the opener works alternately (open-stop-close-stop-open) by pressing **Key B**.

The **Key C** and **Key D** are reserved for garage door opener, swing gate opener in our brand. While if you want to use **Key C** and or **Key D** to control a second sliding gate opener, an external receiver (optional) is necessary.

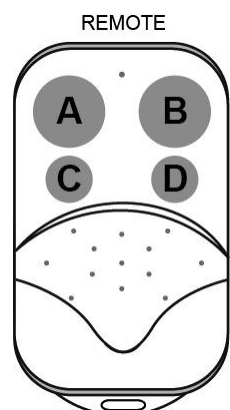

## Troubleshooting

Have a multimeter to check voltage and continuity. Use caution when checking high voltage terminals.

Symptom	Possible Solution(s)
The remote control does not emit any single	Check the batteries are exhausted, replace them if necessary.
The operator doesn't run.	<ol style="list-style-type: none"><li>1. Make sure that the power cord is properly plugged into the mains outlet.</li><li>2. Check the fuse is blown in the control board; if necessary, identify the reason for the failure and then replace a new one.</li><li>3. Make sure the photocell beam is not blocked if the photocell is used. Check the terminal 12 should be shorted with terminal 13 by a jumper wire. Please reset this jumper wire if it is loss.</li></ol>
The gate starts but it is immediately stop or reverse	<ol style="list-style-type: none"><li>1. The selected force is too small to move the gate. Turn the Potentiometer clock-wise to increase the force.</li><li>2. Disconnect the gate from the gate operator and check that the gate slides freely without any binding.</li></ol>

## Maintenance

Every six months check the following items for proper operation of the unit.

- \* Lubricate shafts and sprockets.
- \* Keep operator clean at all times.
- \* Check and tighten anchors bolts.
- \* Check for loose or corroded wire
- \* Ensure the operator is well earthed, and correctly terminated.
- \* Always check the Stop/Reverse in case of obstruction function when performing any maintenance. If this function can't be made operable, remove this operator from service until the cause of the malfunction is identified and corrected.





According to Waste of Electrical and Electronic Equipment (WEEE) directive, WEEE should be separately collected and treated. If at any time in future you need to dispose of this product please do NOT dispose of this product with household waste. Please send this product to WEEE collecting points where available.

[www.AlekoProducts.com](http://www.AlekoProducts.com)

7106 S 220th St, Kent WA 98032 USA

[sales@alekoproducts.com](mailto:sales@alekoproducts.com)

©2016-2019 ALEKO All Rights Reserved